



# TILE & STONE INSTALLATION TOOLS

2026



## KEY MILESTONES

- 1979** Company is founded
- 1980** QEP opens first official corporate facility
- 1984** QEP releases the world's first dual rail tile cutter
- 1986** Named a member of Inc. Magazine's 500 second year in a row
- 1989** QEP begins manufacturing tile spacers
- 1990** Founder interviewed by "Ceramic Tiling Tools"
- 1999** QEP available in all 50 states and 49 countries worldwide
- 2003** A QEP brand sponge is now sold every 7 seconds
- 2004** European expansion in England, Ireland and France
- 2010** QEP begins Sponge Production in the US
- 2011** First to market with the LASH style leveling system
- 2014** The QEP 900XT Pro Tile Saw wins Surfaces 2014 Best New Product Award
- 2022** QEP consolidates shipping and opens new 212,000 sq. ft. warehouse and shipping facility in Dalton, Georgia
- 2022** Filed Patent for LASH Xtreme Large Tile Leveling System
- 2022** Filed Patent for Single Action Dual Suction Cup
- 2022** Filed Patent for Cork Handled Trowels
- 2024** The QEP Tile Trim Square wins FLOOR Trends & Installation's 2024 Top Flooring Products Award
- 2025** QEP Introduced a New Tile Cutter Series- Katana Single Rail (SR31 and SR41)
- 2025** QEP Introduced a Large Format Product Series- GPTP -Gauge Porcelain Tile Panel Solutions
- 2025** Transferred all LASH Tile Leveling Systems manufacturing to the USA

QEP® was founded in 1979 with a vision of excellence in tile installation tools and impeccable timing: At the rise of home improvement industry, and the boom of the DIY movement. Today, through innovation and ingenuity, QEP is the #1 Tile Tool Brand Worldwide.

An iconic, trusted brand for the world's largest retailers and flooring distributors, QEP continues to expand their product line with best-in-class product design, eco-friendly packaging, and optimal trend merchandising.

We are continuing to work to ensure that we are fulfilling the needs of the professional installers of today and tomorrow.

## A Brand You Can Trust

QEP is an iconic brand with an established market in more than 100 countries, it is founded on decades of experience in the industry, fosters true partnerships with national trade affiliates and training certification partners, and is committed to exceeding your expectations.

- Award-winning, multilingual Customer Service Team
- Expert-level technical support to receive and resolve your product and industry questions
- Research and Development Team dedicated to improving, advancing, enhancing, and innovating our products through best-in-class engineering
- Partnership with industry affiliates including NTCA, TCNA, CTEF, FCEF, FCICA, WFCA, AFT, CFI and IUPAT among others, to support and invest in the trade and the future of the industry
- 600K Sq. Ft. of warehouse and manufacturing space ensures that we are always in stock, inventory is always available
- Dedicated social media and brand ambassador programs to ensure that we are speaking with and engaging with the installer of today

## QEP's Commitment to Sustainability

We are always challenging ourselves to reimagine the design of products and packaging to ensure that we are using materials which are recycled, biodegradable or otherwise earth friendly.

---

**Professional Tools. Professional Results.  
Since 1979**

---

Se habla español | français parlé

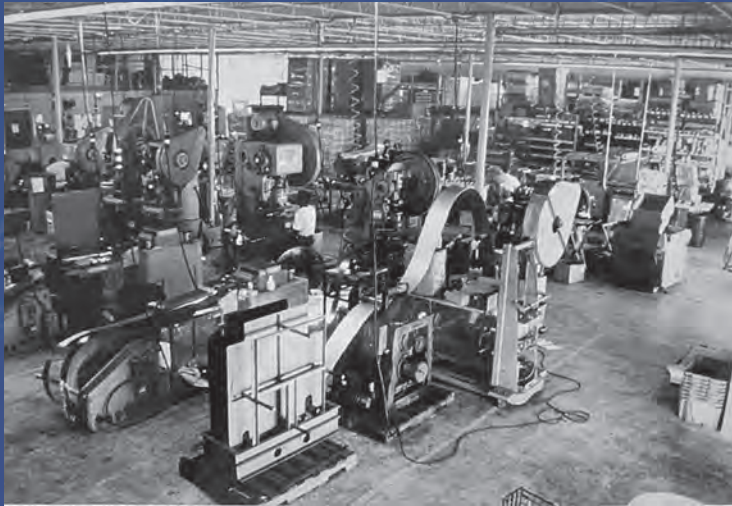
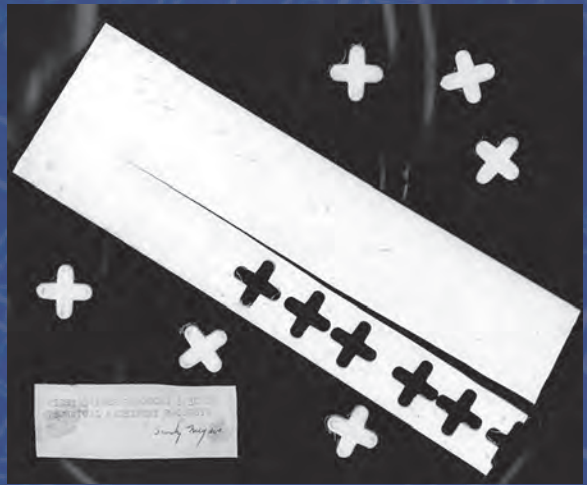

The ORIGINAL **LASH**®  
LEVEL ALIGN SPACE HOLD

## The World's Best Tile Leveling System

US07992354B2

(12) **United States Patent**  
Doda, Jr.

(10) Patent No.: **US 7,992,354 B2**  
(45) Date of Patent: **Aug. 9, 2011**

(54) **DEVICE FOR LEVELING AND ALIGNING TILES AND METHOD FOR LEVELING AND ALIGNING TILES**

(73) Inventor: **Robert C. Doda, Jr.**, Pompano Beach, FL (US)

(73) Assignee: **Q.E.P. Co., Inc.**, Boca Raton, FL (US)

(\*) Notice: Subject to any disclaimer, the term of this patent is extended or adjusted under 35 U.S.C. 154(b) by 382 days.

(21) Appl. No.: **12/879,175**

(22) Filed: **Mar. 24, 2008**

(65) **Prior Publication Data**  
US 2008/0256094 A1 Oct. 2, 2008

**Related U.S. Application Data**

(60) Provisional application No. 60/920,430, filed on Mar. 20, 2007.

(51) Int. Cl. **E04F 21/28** (2006.01)

(52) U.S. Cl. **52127.7; 52749.11; 52747.11**

(58) Field of Classification Search: **52/127.5; 52/127.7; 08, 100, 389, 384, 385, 386, 769, I; 52749.11; 540.15; 5607; 53520**

See application file for complete search history.

(56) **References Cited**

**U.S. PATENT DOCUMENTS**

2,061,190 A *	5/1937	Sauer	5/2008
2,709,212 A *	11/1956	Blamont et al.	5/2010
3,384,692 A *	7/1968	Kend	5/2007
4,307,125 A *	9/1983	Olmstead Jr.	5/2013
4,610,434 A *	1/1985	Comstock	6/2007
4,933,141 A *	9/1990	Jain	5/2007
5,535,566 A *	7/1996	Wynn et al.	5/2008

**FOREIGN PATENT DOCUMENTS**

JP	630604000015	8/2003
MX	660323802	6/1992
WO	99/2006/01608	A2 8/2006

**OTHER PUBLICATIONS**

International Search Report dated Jul. 16, 2008 for international Application No. PCT/US2008/010106

Faloutsos, Charles, Certified English Language Translation of Italian Patent Publication No. EP0603260A00003, published Aug. 16, 2003, dated Mar. 23, 2011, 19 Pages

\* cited by examiner

**Primary Examiner** — David Dims  
**Assistant Examiner** — Ali Akhavan  
**(74) Attorney Agent or Firm** — Christian Parker & Hale, LLP

**ABSTRACT**

A tile leveling device is provided. The device includes a main member, a first section extending transversely from the main member for receiving a first tile and a second section extending transversely from the main member in a direction opposite the first section for receiving a second tile. A member is provided for penetrating the main member and exerting a force on the tiles for leveling them relative to each other. A method for leveling tiles is also provided.

**10 Claims, 6 Drawing Sheets**





# UNPARALLELED COMMITMENT TO QUALITY, PERFORMANCE AND PARTNERSHIP

At QEP®, our success is measured in the reliability of our tools, the satisfaction of our customers and the trust placed in the brand by the professional installers and customers that use them.

## QUALITY

### WORLD-CLASS MANUFACTURING & INNOVATION

In pursuing this success, we have invested in building relationships with some of the world's foremost experts in industrial design, manufacturing, and tooling. Rigorous quality-assurance measures have been put in place to ensure every product that carries our brand exceeds the expectation of our customers.

## PERFORMANCE

### SATISFACTION GUARANTEED

At QEP customer satisfaction is paramount, which is why we offer a 'best in class' warranty program. All QEP GTP Solutions™, electric tile saws, mixers, tile cutters, and the electric suction cups carry a 3 year Manufacturer's Limited Warranty. All QEP hand tools carry a 1-year Manufacturer's Limited Warranty ensuring the product is free from defects in materials and workmanship. Visit us online at [qep.com](http://qep.com) for individual warranty terms and details.

## PARTNERSHIP

### INVESTING IN OTHERS

Success does not happen by accident. At QEP, success has been the result of working with passionate, like-minded people that share our commitments and goals. In partnering with installers, trade affiliates and certification partners, we not only ensure that we're developing products that meet the needs of generations of installers, we are investing in the future of the trade itself.

#### AFFILIATES:





## The QEP® Brand of Professional Tools

Established brand leader driving innovation for the world's largest retailers, professional distributors and tile installers, we continue to expand our product line series with best-in-class design, eco-friendly packaging and on trend merchandising.

Our tile tools are designed with premium cutting-edge features and engineered for the specific needs of the installers.

Continuing to expand our product lines with unique design elements, QEP is raising the bar in innovation and performance. an iconic brand, you can find QEP tile tools around the world, everywhere professional tools are sold.

# CONTENTS

## GAUGED PORCELAIN TILE PANEL SOLUTIONS™

GPTP™ RAIL CUTTING SYSTEM, FOLDING WORK TABLE, CARRYING SYSTEM, TRANSPORT CART, VIBRATING SUCTION CUP, TILE BEATER BLOCK

07

## TILE CUTTERS

CUTTERS, SCORING WHEELS

15

## TILE SAWS

23

## DIAMOND BLADES

28

## TILE SPACERS

TILE LEVELING SYSTEMS, HORSESHOE SHIMS, HARD WEDGE TILE SPACERS, PAVER SPACERS, TRADITIONAL & LEAVE-IN SPACERS

34

## TROWELS & FLOATS

41

## DIAMOND TOOLS

NIPPERS, MIXERS, SUCTION CUPS, MALLETS, KNIVES, SEAM TAPE, SPONGES, BACKERBOARD

48

## INSTALLATION & BACKERBOARD TOOLS

NIPPERS, MIXERS, SUCTION CUPS, MALLETS, KNIVES, SEAM TAPE, SPONGES, BACKERBOARD

56

## TEAR-OUT TOOLS

SCRAPERS

75

## KNEE PADS

79

## UNDERLAYMENTS & BARRIERS

NATURAL CORK, AQUABAR®

82

## DISPLAYS & MERCHANDISING

GONDOLAS, COUNTER DISPLAYS, GRAVITY DISPLAYS, FLOOR DISPLAYS, PALLETS

85



# GAUGED PORCELAIN TILE PANEL SOLUTIONS™

QEP® offers GTP Solutions™ designed for handling and cutting large tile panels. The QEP GTP Solutions™ product series includes a GTP™ Rail Cutting System, Folding Work Table, Carrying System, Transport Cart and Vibrating Suction Cup. When working with large tile panels, these specialized tools are crucial for ensuring precise cuts, safe handling, and efficient installation. They are engineered to support the added weight and larger format tile panels, simplifying installation while delivering professional-grade results.

# GPTP™ RAIL CUTTING SYSTEM - 10'

Rail Carry Bag



Rails

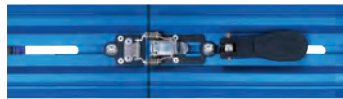
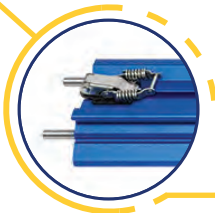

Spring clips for quick and easy length extension

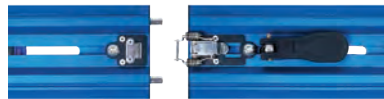

Four adjustable non-marring suction cups underneath each rail



Accessory Bag



Breaker Bar

Cutting Head

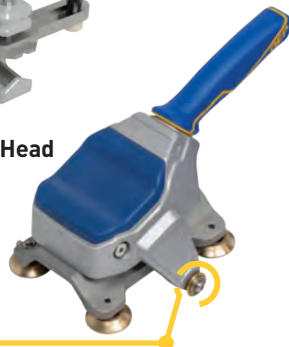

REPLACEMENT SCORING WHEEL:  
21178 7/8" Titanium-Coated Tungsten Carbide Scoring Wheel (3/cs)



- 10' Under mount rail system with (3) 3'-6" rails featuring spring clips for quick and easy length extension
- Each rail is equipped with four non-marring suction cups allowing alignment and stability by maintaining consistent pressure while scoring smooth to semi- textured tiles
- The Cutting Head features reversible cutting wheel placement and a Palm Pad for added power and control.
- The Breaker Unit includes adjustable leverage points, small internal tips for thin cuts and a slide handle for increased breaking leverage
- Includes 2 carrying bags- one for breaker unit and cutting head and a separate bag for the rails

Item No.	Description	Case Qty	Packaging
75025	GPTP™ Rail Cutting System	1	Carton



**Adjustable knobs for precise leverage and positioning**



**Slide handle for increased breaking leverage**



**Adjustable leverage points and small tips for thin cuts**



**Reversible cutting wheel placement**



**Palm pad for increased power and control**



**SCAN HERE** FOR MORE PRODUCT INFORMATION

# GPTP™ Folding Work Table - 5' x 6' x 32"



- Metal legs fold up along the rails for easy storage and transporting
- Quick connect brackets for adding a second table
- Cross rails can be adjusted front to back for different support areas
- 2" wide leveling feet
- Laser etched increments help line up cross support rails

Folding legs for easy assembly

## Easily double your work surface by connecting two tables



Quick connector to connect two tables

# THE PERFECT SOLUTION FOR LARGE PANEL TILES



Quick connecting brackets to add additional tables.

Each table measures 5' deep by 6' long and is 32" high.

Sturdy cross rails adjust to customize support level.

Works seamlessly with our GTPT™ Carrying System and GTPT™ Transport Cart. (see pages 12 & 13)



Item No.	Description	Case Qty	Packaging
75027	GTPT™ Folding Work Table	1	Carton

SCAN HERE FOR MORE PRODUCT INFORMATION



# GPTP™ Carrying System

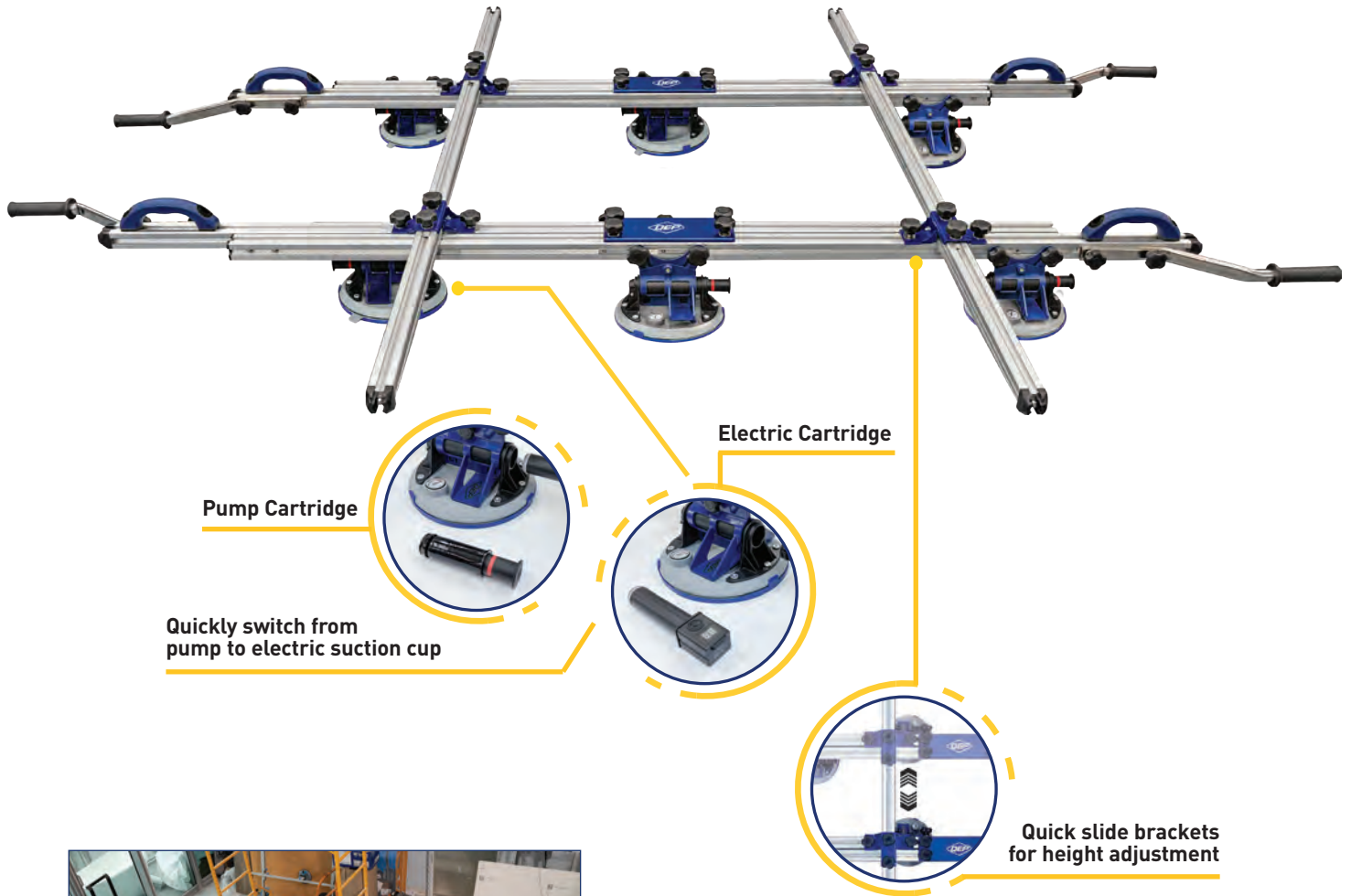

Pump Cartridge

Quickly switch from pump to electric suction cup

Electric Cartridge

Quick slide brackets for height adjustment



- Suitable to carry tile up to 10' x 5'
- Each suction cup can be easily removed and used individually holding up to 220 lbs. (98 kg) each
- 8" grey non-marring suction cups providing consistent suction on smooth and semi textured surfaces
- Four top fixed handles and four repositionable extension handles provide a firm grip for carrying tile
- All electric pumps include a lithium battery and USB charging cord
- Includes 6 electric cartridges and 6 pump cartridges
- Includes a carry bag



Item No.	Description	Case Qty	Packaging
75028	GPTP™ Carrying System	1	Carton



SCAN HERE FOR MORE PRODUCT INFORMATION

# GTP™ Transport Cart -60" H x 60" W x 32" D



24" top adjustable hook prevents panels from falling forward

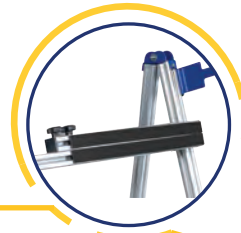

Extension arms add an extra 3.5 feet of support



- Heavy Duty Aluminum A-Frame holds panels up to 5' x 10'
- Four extension arms add an extra 3.5 feet of support when transporting panels
- Two front stops prevent panels from sliding off the bottom
- Adjustable center cross bar provides support for smaller tiles
- Base support slats hold smaller pieces of cut tile
- 5" Non-marring rubber wheels with two front locking casters
- 24" top adjustable hook prevents panels from falling forward



Item No.	Description	Case Qty	Packaging
75029	GTP™ Transport Cart	1	Carton



SCAN HERE FOR MORE PRODUCT INFORMATION

# GPTP™ Vibrating Suction Cup

**NEW**

- Recommended for all large format tile installations
- Eliminates trapped air bubbles under tile
- Variable speed trigger controls vibration
- Can be used on floor and wall tile
- Includes two 20 V lithium batteries with charger and carry case



Item No.	Description	Case Qty	Packaging
75031	GPTP™ Vibrating Suction Cup	1	Carrying Case



SCAN HERE FOR MORE PRODUCT INFORMATION

# GPTP™ Tile Beater Block

**NEW**



- Recommended for all large-format tile installations per the NTCA Reference Manual.
- Gentle tapping tile eliminates air bubbles trapped between the tile and thinset
- Durable rubber polymer protects tile
- The ergonomic handle grip is designed to reduce strain and minimize hand fatigue
- Sturdy metal plate reinforced with durable rubber for balanced weight and impact absorption



Item No.	Description	Case Qty	Packaging
75033	GPTP™ Tile Beater Block	4	Vinyl Wrap



SCAN HERE FOR MORE PRODUCT INFORMATION



# TILE CUTTERS & SCORING WHEELS

QEP offers professional cutters for cutting tile, porcelain, mosaics and other materials. The QEP Katana™ Single Rail Tile cutters, multipurpose Big Clinkers, lightweight Slimline cutters and traditional cutters are engineered for the Pros by the Pros.

Designed to make cutting easy with features like side arm extensions, ball bearing slides and locking features, QEP puts quality and safety first.

# Katana™ SR-41 Tile Cutter



Features front and back spring pads for support and shock absorption

Clearview rear mounting scoring wheel

Carry Case

- Smooth score chassis with 11 enclosed ball bearing rollers
- Clearview rear mounting scoring wheel with quick release breaker bar designed for precise cutting
- Heavy duty cast aluminum base with front and back steel spring plates
- Full length 20" side wing support arms prevent tile dipping
- Adjustable fence with positive stops at 22½", 45 and 90°
- 20" Extended handle for maximum breaking power
- Fence is designed to fit and store by locking in place within the cutter
- Flip-up rip guide for straight or angled cuts
- Includes carry case for easy transport
- Includes Cutting wheel



Item No.	Description	Case Qty	Packaging
10410	Katana SR-41 Tile Cutter	1	Carton



**REPLACEMENT SCORING WHEEL:**  
21131 7/8" PREMIUM Titanium-Coated Tungsten Carbide Ball Bearing Scoring Wheel (6/cs)



**RIP CUT**  
10410: Up to 41" Tile



**DIAGONAL**  
10410: Up to 29" Tile



**TILE DEPTH**  
5/8" Max.



SCAN HERE FOR MORE PRODUCT INFORMATION

# Katana™ SR-31 Tile Cutter



Clearview rear mounting scoring wheel

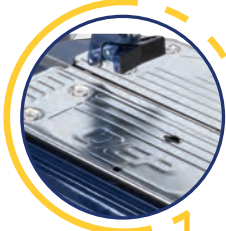

Features spring pads for support and shock absorbment



- Smooth score chassis with 11 enclosed ball bearing rollers
- Clearview rear mounting scoring wheel with quick release breaker bar designed for precise cutting
- Heavy duty cast aluminum base with front steel spring plate and rear premium rubber
- Full length 20" side wing support arms prevent tile dipping
- Adjustable fence with positive stops at 22½, 45 and 90°
- 20" Extended handle for maximum breaking power
- Fence is designed to fit and store by locking in place within the cutter
- Flip-up rip guide for straight or angled cuts
- Includes Cutting wheel



**REPLACEMENT SCORING WHEEL:**  
21131 1/8" PREMIUM Titanium-Coated Tungsten Carbide Ball Bearing Scoring Wheel (6/cs)



**RIP CUT**  
10310: Up to 31" Tile



**DIAGONAL**  
10310: Up to 22" Tile



**TILE DEPTH**  
5/8" Max.

Item No.	Description	Case Qty	Packaging
10310	Katana SR-31 Tile Cutter	1	Carton



SCAN HERE FOR MORE PRODUCT INFORMATION

\*\*Certain materials over 15mm thick can be challenging to cut manually due to their physical properties and potential tensions. It is advisable to conduct sample cuts to assess compatibility.

# Big Clinker® Tile Cutter - 28", 25" & 22½"

## BIG CLINKER®



**22½  
INCH**

**25  
INCH**

**28  
INCH**



- Height adjustable 4-position wheel designed to accommodate various tile thicknesses
- Equipped with replaceable 7/8" titanium-coated tungsten carbide ball bearing scoring wheel
- Side arm extensions to support large format tiles
- Durable chrome plated steel rails
- Rip/Angle guide for fast multiple cuts
- Heavy duty cast aluminum base
- Includes Cutting Wheel



Item No.	Description	Case Qty	Packaging
10800	28" Big Clinker Tile Cutter	1	Printed Carton
10600	25" Big Clinker Tile Cutter	1	Printed Carton
10500	22-1/2" Big Clinker Tile Cutter	1	Printed Carton



**REPLACEMENT SCORING WHEEL:**  
**211230 7/8" PREMIUM**  
 Titanium-Coated Tungsten Carbide Ball Bearing Scoring Wheel (6/cs)



**RIP CUT**  
 10800: Up to 28" Tile  
 10600: Up to 25" Tile  
 10500: Up to 22.5" Tile



**DIAGONAL**  
 10800: Up to 20" Tile  
 10600: Up to 18" Tile  
 10500: Up to 16" Tile



**TILE DEPTH**  
 10800: 5/8" Max.  
 10600: 5/8" Max.  
 10500: 5/8" Max.



SCAN HERE FOR MORE PRODUCT INFORMATION

# Slimline Cutters - 24", 30" and 36"

## SLIMLINE



- Lightweight and easy to carry from site to site
- Equipped with replaceable tungsten-carbide 7/8" ball bearing scoring wheel
- Reinforced thick steel base with tile support arms
- Die cast aluminum rail supports
- Metal rip guide
- Includes Cutting wheel



Item No.	Description	Case Qty	Packaging
10624Q	24" Slimline Manual Tile Cutter, with 2 legs	1	Printed Carton
10636Q	36" Slimline Manual Tile Cutter, with 4 legs	1	Printed Carton
<b>QEP Canada Only</b>			
10632Q	30" Slimline Manual Tile Cutter, with 2 legs	1	Printed Carton

**REPLACEMENT SCORING WHEEL:**  
 21178 7/8" Titanium-Coated Tungsten Carbide Scoring Wheel (3/cs)



**RIP CUT**  
 10624Q: Up to 24" Tile  
 10632Q: Up to 30" Tile  
 10636Q: Up to 36" Tile



**DIAGONAL**  
 10624Q: Up to 18" Tile  
 10632Q: Up to 21" Tile  
 10636Q: Up to 25" Tile



**TILE DEPTH**  
 1/2" Max.

**SCAN HERE** FOR MORE PRODUCT INFORMATION 

# LFT Manual Tile Cutter - 48"



- Ball bearing cutting head for accurate and easy scoring
- Breaking System Lever produces max amount of pressure
- Locking slide to prevent damage in transport
- Locking swivel angle and measurement bar
- Dual breaker bar for narrow and wide tile
- Equipped with replaceable tungsten-carbide 7/8" scoring wheel
- Breaking pads are mounted on springs for better shock absorption
- Cut-out under breaking pads allows for tile cuttings to fall through for easy cleaning
- Includes Cutting wheel



Item No.	Description	Case Qty	Packaging
10480Q	48" LFT Manual Cutter	1	Printed Carton

**REPLACEMENT SCORING WHEEL:**  
21178 7/8" Titanium-Coated Tungsten Carbide Scoring Wheel (3/cs)

**RIP CUT**  
10480Q: Up to 48" Tile

**DIAGONAL**  
10480Q: Up to 34" Tile

**TILE DEPTH**  
5/8" Max.



SCAN HERE FOR MORE PRODUCT INFORMATION

# Tile Cutters - 35" & 24"



- Ball bearing slide for smooth scoring
- Side arm extensions to support large format tiles
- Equipped with replaceable 7/8" titanium-coated tungsten carbide ball bearing scoring wheel
- Durable chrome plated steel rails
- Rip/Angle guide for fast multiple cuts
- Includes Cutting wheel



Item No.	Description	Case Qty	Packaging
10900	35" Tile Cutter	2	Printed Carton
10630	24" Tile Cutter	1	Printed Carton

**REPLACEMENT SCORING WHEEL:**  
21125 7/8" Titanium-Coated Tungsten Carbide Ball Bearing Scoring Wheel (6/cs)

**RIP CUT**  
10900: Up to 35" Tile  
10630: Up to 24" Tile

**DIAGONAL**  
10900: Up to 24" Tile  
10630: Up to 17.5" Tile

**TILE DEPTH**  
1/2" Max.



SCAN HERE FOR MORE PRODUCT INFORMATION

# Tile Cutter - 21"

- High leverage, padded handle makes cutting easier and reduces fatigue
- Durable chrome-plated solid steel rails for smooth scoring
- Powder coated steel base with extra center reinforcement
- Includes replaceable tungsten carbide 10 mm post scoring wheel



Item No.	Description	Case Qty	Packaging
10221Q	21" Tile Cutter	2	Printed Carton



**REPLACEMENT SCORING WHEEL:**  
21127Q  
10 mm Post Scoring Wheel  
(6/cs)



**RIP CUT**  
10221Q: Up to 21" Tile



**DIAGONAL**  
10221Q: Up to 15" Tile



**TILE DEPTH**  
3/8" Max.

# Tile Cutters - 20" & 14"

- Equipped with replaceable 1/2" titanium-coated tungsten carbide scoring wheel
- Durable chrome-plated solid steel rails for smooth scoring
- Powder coated steel base with extra center reinforcement
- Includes Cutting wheel



**20**  
INCH

**14**  
INCH



Item No.	Description	Case Qty	Packaging
10220Q	20" Tile Cutter	4	Printed Carton
10214Q	14" Tile Cutter	6	Printed Carton



**REPLACEMENT SCORING WHEEL:**  
10010HD 1/2"  
Tungsten Carbide Scoring Wheel  
(12/cs)



**RIP CUT**  
10220Q: Up to 20" Tile  
10214Q: Up to 14" Tile



**DIAGONAL**  
10220Q: Up to 14" Tile  
10214Q: Up to 10" Tile



**TILE DEPTH**  
3/8" Max.

# Replacement Wheels for Tile Cutters

ITEM NO.	DESCRIPTION	21127Q 10 mm Wheel	10010HD 1/2" Wheel	21123Q 7/8" Wheel	21125 7/8" Wheel	21178 7/8" Wheel	21131 7/8" Wheel
10480Q	48" LFT Manual Tile Cutter					•	
10636Q	36" Slimline Tile Cutter					•	
10632Q	30" Slimline Tile Cutter					•	
10624Q	24" Slimline Cutter					•	
10900	35" Tile Cutter				•		
10800	28" Big Clinker Tile Cutter			•			
10630	24" Tile Cutter				•		
10600	24" Big Clinker Tile Cutter			•			
10221Q	21" Tile Cutter	•					
10500	22-1/2" Big Clinker Tile Cutter			•			
10220Q	20" Tile Cutter		•				
10214Q	14" Tile Cutter		•				
10310	SR-31 Katana Tile Cutter						•
10410	SR-41 Katana Tile Cutter						•

## 10 mm Post Scoring Wheel



- For cutting ceramic, porcelain and glass tiles
- Tungsten carbide scoring edge for long cutting life
- For use with 10221Q 21" Professional Tile Cutter

Item No.	Description	Case Qty	Packaging
21127Q	10 mm Post Scoring Wheel	6	Hang Card

## 1/2" Tungsten Carbide Scoring Wheel

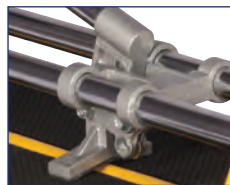

- For cutting ceramic, porcelain and glass tiles
- For use with 10220Q 20" QEP Tile Cutter and 10214Q 14" QEP Tile Cutter

Item No.	Description	Case Qty	Packaging
10010HD	1/2" Tungsten Carbide Scoring Wheel	12	Hang Card

## 7/8" Replacement Scoring Wheels with Ball Bearings

- For cutting ceramic, porcelain and glass tiles
- Ball bearing wheel for smooth scoring
- Designed to use with any tile cutters



- For use with:  
10800 28" Big Clinker Tile Cutter  
10600 24" Big Clinker Tile Cutter  
10500 22 1/2" Big Clinker Tile Cutter

- For use with:  
10900 35" Tile Cutter  
10603 24" Tile Cutter

- For use with:  
10480Q LFT Manual Tile Cutter  
10636Q 36" Slimline Tile Cutter  
10632Q 30" Slimline Tile Cutter  
10624Q 24" Slimline Tile Cutter

- For use with:  
10310 SR-31 Tile Cutter  
10410 SR-41 Tile Cutter

Item No.	Description	Case Qty	Packaging
21123Q	7/8" Premium Tile Cutter Replacement Scoring Wheel with Ball Bearings	6	Hang Card

Item No.	Description	Case Qty	Packaging
21125	7/8" Tile Cutter Replacement Scoring Wheel with Ball Bearings	6	Hang Card

Item No.	Description	Case Qty	Packaging
21178	7/8" Titanium Coated Replacement Scoring Wheel for Multiple Tile Types	3	Hang Card

Item No.	Description	Case Qty	Packaging
21131	7/8" Titanium Coated Replacement Scoring Wheel for Multiple Tile Types	6	Hang Card



## TILE SAWS

QEP's line of award-winning Tile Saws for cutting large format ceramic, porcelain, granite, stone and marble tile are engineered by the pros for the pros. Designed with features such as splash guard water containment systems, extension tables and safety locks, QEP Tile Saws make work easier.

# 49" Bridge Saw

**NEW**

**STRAIGHT CUTS**  
49" with plunge  
47" without plunge

**DIAGONAL CUTS**  
34.5" with plunge  
32" without plunge

**TILE DEPTH**  
2-3/4" max

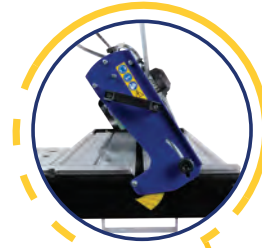

Tilting rail offers various options for angle cuts up to 45°

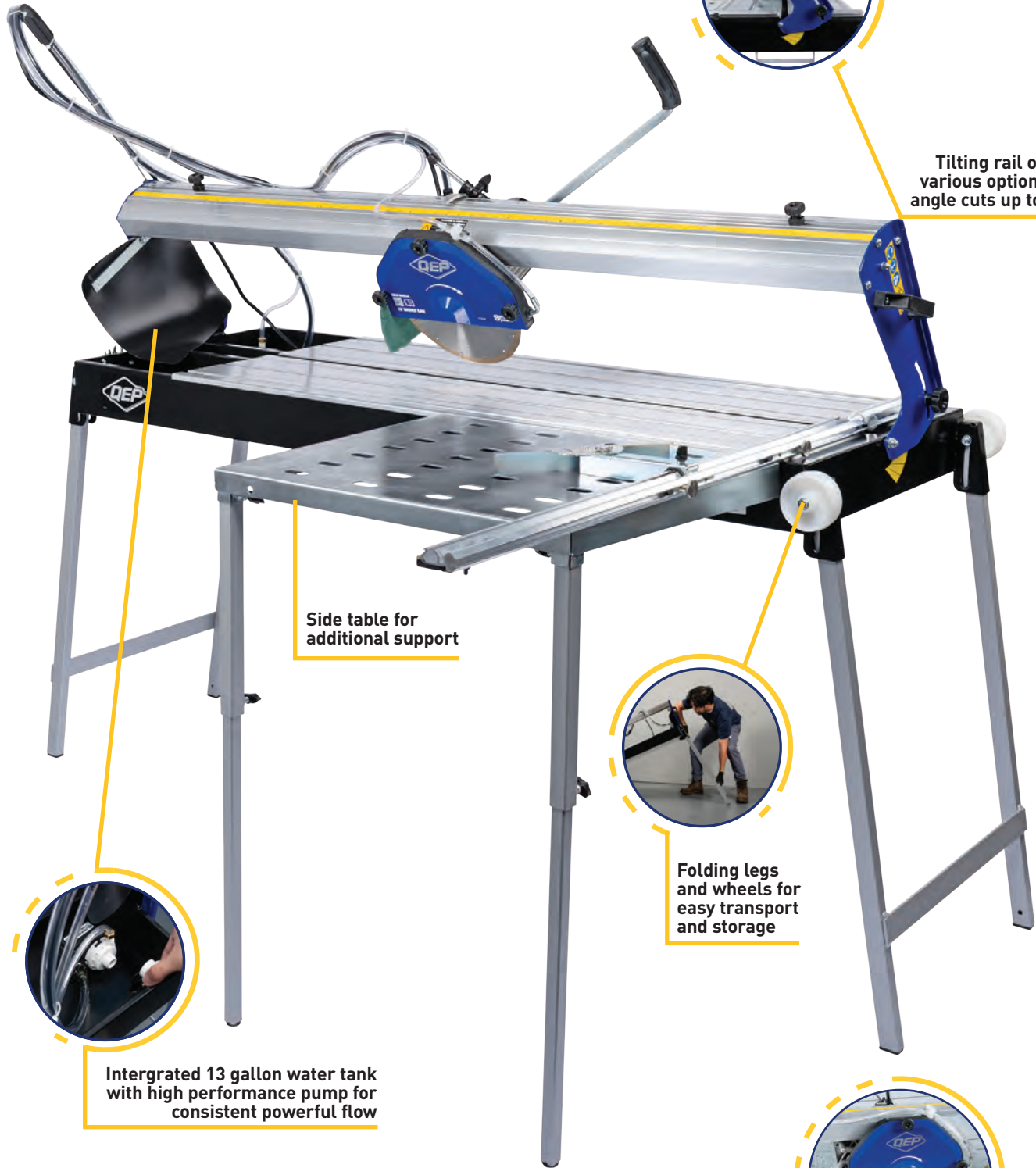

Side table for additional support



Folding legs and wheels for easy transport and storage



Intergrated 13 gallon water tank with high performance pump for consistent powerful flow

Plunge function for interior cuts

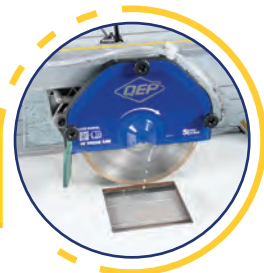

Item No.	Description	Case Qty	Packaging
83249	49" Bridge Saw - 10" Blade	1	Carton



- Fully enclosed electrical cables for safe operation
- Tilting rail for angle cuts up to 45°
- Intergrated 13 gallon water tank
- Durable Heavy Duty Aluminum extruded rails
- Folding legs and transport wheels for easy transport and storage

**ACCESSORIES INCLUDED**

- 10" continuous rim wet diamond blade
- Detachable 3.0 sq. ft. side table
- Angle cutting guide



**SPECIFICATIONS**

Item No	83249
Motor	1.8 HP/120 V ~ 60 Hz. / 12 Amp
Watts	1400 W
RPM	3400
Blade Capacity	10"
Arbor	5/8"
Size	33" H x 63" W x 20.3" D
Weight	118 lbs.

\*Complies with Canadian and U.S. requirements

SCAN HERE FOR MORE PRODUCT INFORMATION



# Power Pro 1HP Wet Tile Saw - 7"

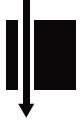

**UNLIMITED  
STRAIGHT  
CUTS**



**UNLIMITED  
DIAGONAL  
CUTS**



**15°, 35° & 45°  
MITER CUTS**



**1-1/8" MAX  
TILE DEPTH**



- Direct-drive, 1 HP motor is quiet and delivers power to handle ceramic, slate, marble, granite and porcelain\*\*
- Water catch system reduces water run off and recycles water back into the reservoir minimizing fill frequencies
- Large die-cast aluminum cutting table for precision 15°, 30° and 45° miter cuts
- Adjustable rip and sliding angle guides for accurate production cuts
- Lock on/off switch with key provides additional safety
- Tested and Compliant - Exceeds OSHA Silica Rule 29 CFR 1926.1153

## ACCESSORIES INCLUDED

- 7" continuous rim wet diamond blade
- Locking rip guide
- Angle cutting guide
- Folding bench stop



## SPECIFICATIONS

Item No	22900Q
Motor	1 HP / 120 V ~ 60 Hz. / 6.5 Amps
Watts	750
RPM	3600
Blade Capacity	7"
Arbor	5/8"
Size	22.5" L x 18" W x 8" H
Weight	29 lbs

\*Complies with Canadian and U.S. requirements

Item No.	Description	Case Qty	Packaging
22900Q	7" Power Pro 1HP Wet Tile Saw	1	Printed Carton

\*\*for porcelain and hard tile we recommend QEP's Black Widow Blade (7-7008BW)

SCAN HERE FOR MORE PRODUCT INFORMATION



# 700XT Wet Tile Saw -7"

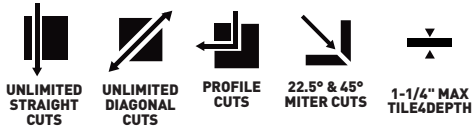

- Direct-drive, 3/4 Peak HP motor is quiet and power to handle ceramic, slate, marble, granite and porcelain
- Water catch system reduces water run-off and recycles water back into the reservoir minimizing fill frequencies
- Adjustable rip and sliding angle guides for accurate production cuts
- 8" Extension side table to support large tile

## ACCESSORIES INCLUDED

- 7" continuous rim wet diamond blade • Locking rip guide
- Angle cutting guide • Blade wrench



## SPECIFICATIONS

Item No	22700Q
Motor	3/4-Peak HP/120 V ~ 60 Hz. / 4.8 Amps
Watts	550
RPM	3600
Blade Capacity	7"
Arbor	5/8"
Size	20.08" L x 15.74" W x 9.88" H
Weight	23 lbs

\*Complies with Canadian and U.S. requirements

Item No.	Description	Case Qty	Packaging
22700Q	7" 700XT Tile Wet Saw	1	Printed Carton



SCAN HERE FOR MORE PRODUCT INFORMATION

# Torque Master XT Portable Wet Tile Saw - 4"

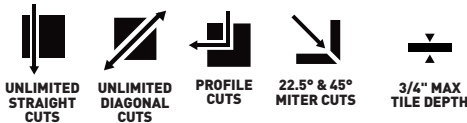

- Direct-drive, 3/5 HP motor is quiet and delivers power to handle ceramic, slate, marble, granite and porcelain
- Water catch system reduces water run-off and recycles water back into the reservoir minimizing fill frequencies
- Fully adjustable miter guide with unique ratchet mechanism
- 2 side extension tables that add 5" of cutting surface

## ACCESSORIES INCLUDED

- 4" continuous rim diamond blade (#6-4003Q)
- 45° angle guide • Blade guard



## SPECIFICATIONS

Item No	22400Q
Motor	3/5 HP / 120 V ~ 60 Hz. / 4 Amps
Watts	450
RPM	4600
Blade Capacity	4"
Arbor	5/8"
Size	14.3" L x 15.8" W x 4.6" H
Weight	8 lbs

\*Complies with Canadian and U.S. requirements

Item No.	Description	Case Qty	Packaging
22400Q	4" Torque Master XT Portable Wet Tile Saw	1	Printed Carton



SCAN HERE FOR MORE PRODUCT INFORMATION

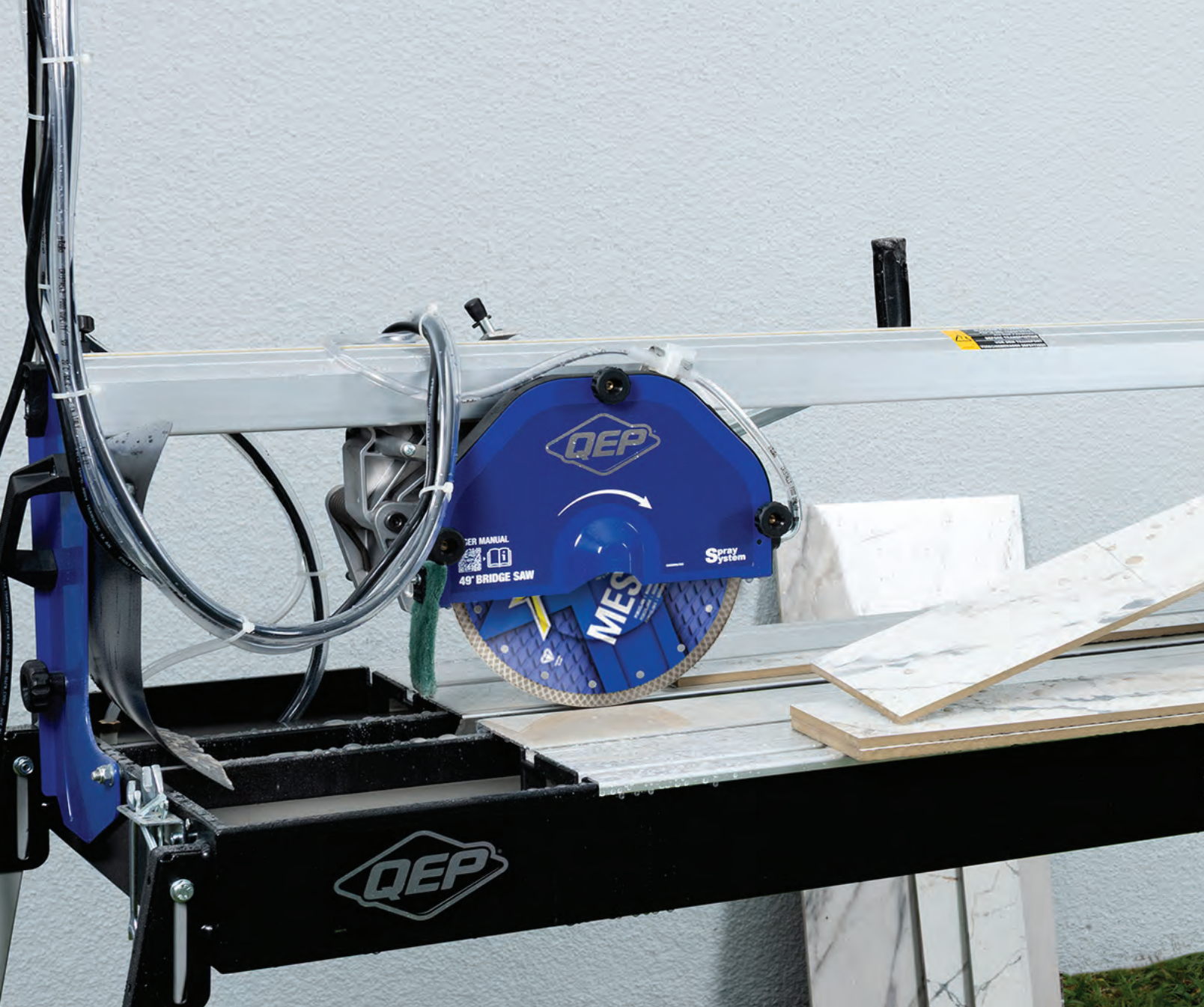

## DIAMOND BLADES

QEP sets the standard in diamond blade performance, leading the industry with continuous innovation and one of the most comprehensive blade assortments available. Our lineup includes Continuous, Mesh, Segmented, and Turbo rim blades engineered for precision and durability.

From Xtreme® Pro Series offering versatility and cutting power for the most demanding applications, to the legendary Black Widow®, Hot Dog®, Gold Series, and Glass Series. QEP diamond blades deliver fast, clean, and reliable cuts across tile, stone, and glass—giving professionals total confidence on every job.

# X TREME<sup>™</sup> PRO-SERIES

## X TREME<sup>™</sup> PRO-SERIES 7" Segmented Diamond Blade

**NEW**



 SUPERIOR BRAZED DIAMOND BONDING

- Deep segment cut-outs enable fast efficient cutting through tough materials
- Durable blade engineered for long lasting performance
- Segmented slots cool the blade by allowing airflow and reducing heat buildup

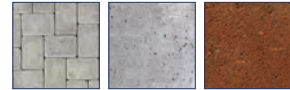

DESIGNED FOR CUTTING  
PAVERS, CONCRETE AND BRICK

Item No.	Description	Rim Height	Width	Arbor Size	Max RPM	No. in Case	Package
7-7007SG	XTREME 7" Segmented Blade	10 mm	2.2 mm	5/8" - 16 mm • 7/8" - 22 mm	8730	4	Ring Clam

SCAN HERE FOR MORE PRODUCT INFORMATION



## X TREME<sup>™</sup> PRO-SERIES 10" Segmented Diamond Blade

**NEW**



 SUPERIOR BRAZED DIAMOND BONDING

- Refined segment design for smoother, cleaner cuts
- Ideal for 3/4" porcelain pavers and 1 3/8" natural stone
- Segmented slots cool the blade by allowing airflow and reducing heat buildup



DESIGNED FOR CUTTING  
PORCELAIN PAVERS  
AND NATURAL STONE

Item No.	Description	Rim Height	Width	Arbor Size	Max RPM	No. in Case	Package
7-1007SG	XTREME 10" Segmented Blade	10 mm	1.8 mm	5/8" - 16 mm • 1" - 25 mm	6115	4	Ring Clam

SCAN HERE FOR MORE PRODUCT INFORMATION



# XTREME<sup>®</sup> PRO-SERIES Mesh Diamond Blades

**NEW**

- Reinforced hub reduces flexing and wobbling for more accurate cuts
- Diamond Mesh pattern enhances cutting speed, while the integrated holes improve cooling efficiency
- 3/4" Blade is compatible with angle grinders

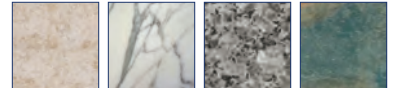

DESIGNED FOR CUTTING PORCELAIN TILE, MARBLE, GRANITE AND SLATE



Item No.	Description	Rim Height	Width	Arbor Size	Max RPM	No. in Case	Package
7-3009MH	XTREME 3-1/4" Mesh Blade	10 mm	1.4 mm	5/8" - 16 mm • 7/8" - 22 mm	15000	4	Ring Clam
7-7009MH	XTREME 7" Mesh Blade	10 mm	1.6 mm	5/8" - 16 mm • 7/8" - 22 mm	8730	4	Ring Clam
7-1009MH	XTREME 10" Mesh Blade	10 mm	1.6 mm	5/8" - 16 mm • 7/8" - 22 mm	6115	4	Ring Clam

\*4" can be used for wet/dry cutting, other sizes are for wet cutting only.



# XTREME<sup>®</sup> PRO-SERIES Turbo Diamond Blade

**NEW**

- Brazed Diamond serrated rim for fast cuts with minimal chipping, while maintaining precision
- Compact turbo blade is designed for creating openings for electrical switch boxes, floor vents, toilet flanges and cover plates
- Cooling System ensures longevity and consistent performance by prevents overheating during prolonged use



DESIGNED FOR CUTTING PORCELAIN TILE, MARBLE, GRANITE, BRICK AND PAVERS



Item No.	Description	Rim Height	Width	Arbor Size	Max RPM	No. in Case	Package
7-3006TB	XTREME 3-3/8" Turbo Blade	7 mm	1.8 mm	5/8" - 16 mm • 7/8" - 22 mm	15000	4	Ring Clam

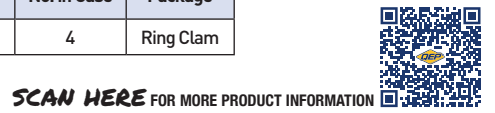

# Black Widow™ Continuous Rim Diamond Blades

**NEW**

- New Reinforced steel hub delivers superior core strength and minimizes flexing
- Precision laser-cut cut “Diamond shaped” vents help maintain a cooler temperature for extended blade life
- Premium Grade Continuous rim design delivers smooth cuts with exceptional precision—perfect for professional tile work

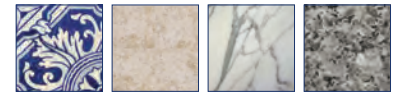

DESIGNED FOR CUTTING CERAMIC AND PORCELAIN TILE, MARBLE AND GRANITE



SCAN HERE FOR MORE PRODUCT INFORMATION



SUPERIOR BRAZED DIAMOND BONDING

Item No.	Description	Rim Height	Width	Arbor Size	Max RPM	No. in Case	Package
7-4008BW	4" Black Widow®	7 mm	1.2 mm	5/8" - 16 mm 7/8"-22 mm	15000	5	Ring Clam
7-7008BW	7" Black Widow®	7 mm	1.2 mm	5/8" - 16 mm 7/8"-22 mm	8730	5	Ring Clam
7-8008BW	8" Black Widow®	7 mm	1.2 mm	5/8" - 16 mm 7/8"-22 mm	7640	5	Ring Clam
7-1008BW	10" Black Widow®	7 mm	1.2 mm	5/8" - 16 mm 1" - 25 mm	6115	5	Ring Clam

\*4" can be used for wet/dry cutting, other sizes are for wet cutting only.

# Hot Dog™ Continuous Rim Diamond Blades

**NEW**

## Introducing the Improved Hot Dog Continuous Rim Diamond Blades

- Reinforced steel hub delivers superior core strength and minimizes flexing
- Precision laser-cut “Hot Dog” vents help maintain a cooler temperature for extended blade life
- Premium-Grade Continuous rim design delivers smooth cuts with exceptional precision—perfect for professional tile work

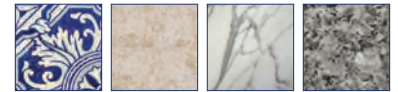

DESIGNED FOR CUTTING CERAMIC AND PORCELAIN TILE, MARBLE AND GRANITE

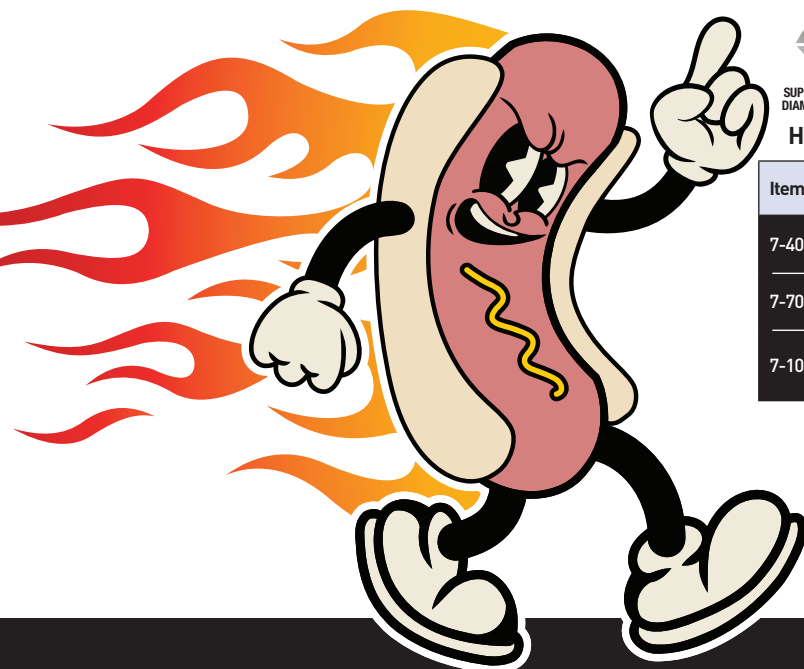

SUPERIOR BRAZED DIAMOND BONDING

Hot Dog Premium blade for ceramic, porcelain, marble and granite

Item No.	Description	Rim Height	Width	Arbor Size	Max RPM	No. in Case	Package
7-4004H	4" Hot Dog Blade	7 mm	1.2 mm	5/8" - 16 mm 7/8" - 22 mm	15000	5	Ring Clam
7-7004H	7" Hot Dog Blade	7 mm	1.2 mm	5/8" - 16 mm 7/8" - 22 mm	8730	5	Ring Clam
7-1004H	10" Hot Dog Blade	7 mm	1.2 mm	5/8" - 16 mm 1" - 25 mm	6115	5	Ring Clam

\*4" can be used for wet/dry cutting, other sizes are for wet cutting only.

SCAN HERE FOR MORE PRODUCT INFORMATION



# Gold Diamond Series Blades

**NEW**



- Premium-grade, thin-rim diamond blade for cutting porcelain and ceramic tile, marble, granite and slate
- High-quality diamond grit ensures durability and precision



SUPERIOR BRAZED  
DIAMOND BONDING

Item No.	Description	Rim Height	Width	Arbor Size	Max RPM	No. in Case	Package
7-4003Q	4" Continuous Rim	7 mm	1.6 mm	5/8" - 16 mm 7/8" - 22 mm	15000	4	Ring Clam
7-7003Q	7" Continuous Rim	7 mm	1.6 mm	5/8" - 16 mm	8730	4	Ring Clam
7-8003Q	8" Continuous Rim	7 mm	1.6 mm	5/8" - 16 mm	7640	4	Ring Clam
7-1003Q	10" Continuous Rim	7 mm	1.6 mm	5/8" - 16 mm	6115	4	Ring Clam

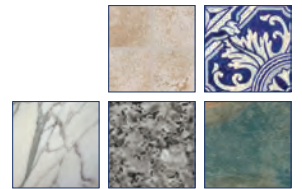

DESIGNED FOR CUTTING  
PORCELAIN AND CERAMIC TILE,  
MARBLE, GRANITE AND SLATE



\*4" can be used for wet/dry cutting, other sizes are for wet cutting only.

SCAN HERE FOR MORE PRODUCT INFORMATION

# Glass Diamond Series Blades

**NEW**



- Ultra fine cutting edge for exceptionally clean accurate cuts
- Wet cutting of glass tile, mosaic, frosted and textured glass and stained glass



SUPERIOR BRAZED  
DIAMOND BONDING



Item No.	Description	Rim Height	Width	Arbor Size	Max RPM	No. in Case	Package
6-4006GLQ	4" Continuous Rim	7 mm	1.6 mm	5/8" - 16 mm 7/8" - 22 mm	15000	3	Ring Clam
6-7007GL	7" Continuous Rim	7 mm	1.6 mm	5/8" - 16 mm	8730	3	Ring Clam

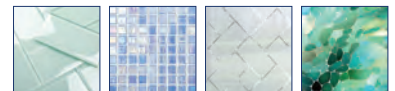

DESIGNED FOR CUTTING  
GLASS TILE, MOSAIC, FROSTED AND  
TEXTURED GLASS AND STAINED GLASS



\*4" can be used for wet/dry cutting, other sizes are for wet cutting only.

SCAN HERE FOR MORE PRODUCT INFORMATION



# TILE LEVELING SYSTEM

QEP offers a variety of systems and spacer styles to eliminate tile lippage.

LASH® XL Tile Leveling System, The original LASH® Tile Leveling System and LASH® 360 Tile Leveling System are all two-part systems to eliminate uneven tiles.

Our horseshoe shims, flexible tile spacers, hard tile spacers, and "T" tile spacers are all solid options for aligning floor and wall tile based on your installation preferences.



MADE IN USA



The ORIGINAL **LASH**  
LEVEL ALIGN SPACE HOLD

**LASH XL**  
LEVEL ALIGN SPACE HOLD

**LASH 360**  
LEVEL ALIGN SPACE HOLD

Precision Leveling. Made in the USA.

# The Original LASH® Tile Leveling System



## The World's Best Tile Leveling System

The Original LASH® Tile Leveling System is designed for quick installation and reduces costly call backs by ensuring that the finished floor surface is lippage-free. This time-saving system helps adjust the height of the tiles and evenly holds their edges throughout the curing process of the setting material.

### Two-part system eliminates uneven tile - Clips and Wedges

- For tile between 1/4" and 7/16" thick
- Proprietary poly blend for secure holding and easy break off
- Clips provide 1/16" or 1/8" grout widths
- May be combined with regular tile spacers for wider joints - up to 1/4"
- Wedges are reusable

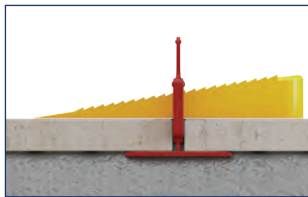
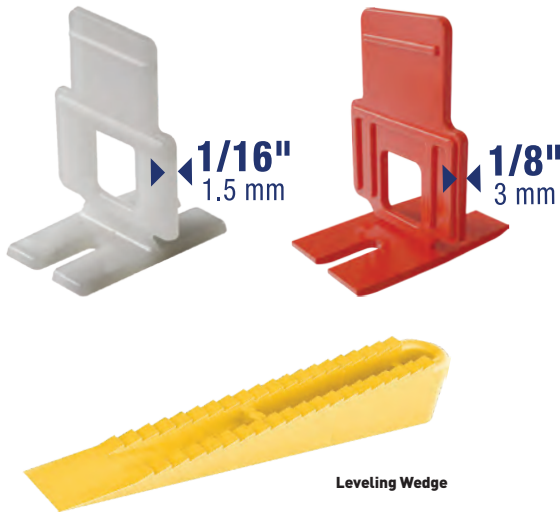

LASH® Flat Clip for Floor and Wall Tiles

Item No.	Description	Qty	Case Qty	Packaging	Pallet Qty
99730	LASH® Clips 1/16"	100	8	Poly Bag	90
99731	LASH® Clips 1/16"	300	4	Printed Carton	36
99790	LASH® Clips 1/16"	500	1	Printed Carton	160
99740	LASH® Clips 1/16"	1000	1	Printed Carton	90
99741-6	LASH® Project Pack - 100 1/16" clips/100 Wedges	200	6	Shelf Carton	90
99792	LASH® Clips 1/16"	2000	1	Printed Carton	48
99781	LASH® Clips 1/8"	100	8	Poly Bag	90
99782	LASH® Clips 1/8"	300	4	Printed Carton	36
99791	LASH® Clips 1/8"	500	1	Printed Carton	160
99783	LASH® Clips 1/8"	1000	1	Printed Carton	90
99793	LASH® Clips 1/8"	2000	1	Printed Carton	48
99726	LASH® Wedges	100	8	Poly Bag	132
99727	LASH® Wedges	300	4	Printed Carton	90
99728	LASH® Wedges	500	4	Printed Carton	60



SCAN HERE FOR MORE PRODUCT INFO

## Pro Installation Pliers

### For faster installation use QEP Pro Installation Pliers

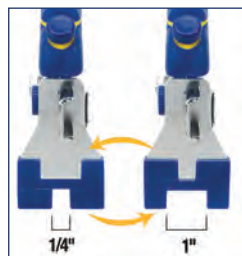

- Easily sets the wedge into the clip, and comfortably applies the right amount of pressure without overtightening
- Use with Original LASH® as well as LASH XL™ Tile Leveling Systems for faster installation
- Stop pin regulates proper pressure at all times
- Co-molded plastic handle with non-slip, rubber grip for comfortable repeat use

Item No.	Description	Case Qty	Packaging
99784	Pro Installation Pliers	6	Hang Card

# LASH XL™ Tile Leveling System



- For tile up to 1/2" thick
- Polymer construction for superior durability and a secure hold
- Clips provide 1/32", 1/16", 1/8" and 3/16" grout widths
- Easy to use, especially with large format tile
- Designed to break off below the surface of the tile for quick and easy removal
- Wedges are reusable

## Two-Part System eliminates uneven tile Clips and Wedges

Lash XL ensures large format tile up to 1/2" thick are leveled and consistently spaced during installation. The Wedges are used in conjunction with the Leveling Clips to produce even grout lines and align neighboring tile delivering a lippage-free surface. For quick and easy removal, Clips are designed to break off below the surface of the tile with a simple kick in the direction of the grout line, or strike of a rubber head mallet.



For faster installation use QEP Pro Installation Pliers. See page 36 for details.

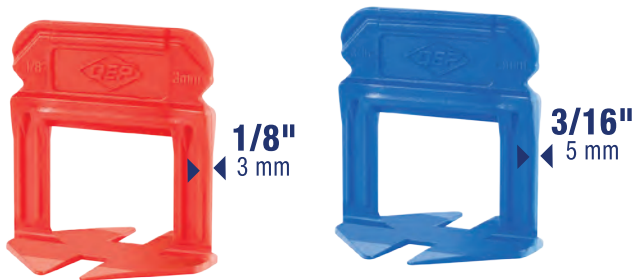

Leveling Wedge

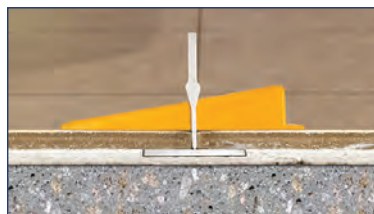

Protection Plate



Recommended when using Tile Leveling Systems to protect soft tile and marble surfaces from possible scratches caused by trapped residual mortar during tightening. See page 40 for details.



Item No.	Description	Qty	Case Qty	Packaging	Pallet Qty
99751	LASH XL™ 1/32" Leveling Clips	100	8	Poly Bag	54
99971	LASH XL™ 1/32" Leveling Clips	300	1	Printed Carton	56
99771	LASH XL™ 1/32" Leveling Clips	500	1	Printed Carton	96
99871	LASH XL™ 1/32" Leveling Clips	1000	1	Printed Carton	40
99776	LASH XL™ 1/32" Leveling Clips	2000	1	Printed Carton	24
99761	LASH XL™ 1/16" Leveling Clips	100	8	Poly Bag	54
99861	LASH XL™ 1/16" Leveling Clips	300	1	Printed Carton	56
99772	LASH XL™ 1/16" Leveling Clips	500	1	Printed Carton	96
99872	LASH XL™ 1/16" Leveling Clips	1000	1	Printed Carton	40
99777	LASH XL™ 1/16" Leveling Clips	2000	1	Printed Carton	24
99769	LASH XL™ 1/8" Leveling Clips	100	8	Poly Bag	54
99869	LASH XL™ 1/8" Leveling Clips	300	1	Printed Carton	56
99773	LASH XL™ 1/8" Leveling Clips	500	1	Printed Carton	96
99873	LASH XL™ 1/8" Leveling Clips	1000	1	Printed Carton	40
99778	LASH XL™ 1/8" Leveling Clips	2000	1	Printed Carton	24
99774	LASH XL™ 3/16" Leveling Clips	500	1	Printed Carton	96
99779	LASH XL™ 3/16" Leveling Clips	2000	1	Printed Carton	24
99762	LASH XL™ Leveling Wedges	100	8	Poly Bag	30
99862	LASH XL™ Leveling Wedges	300	1	Printed Carton	56
99775	LASH XL™ Leveling Wedges	500	1	Printed Carton	64
99780	LASH XL™ Leveling Wedges	2000	1	Printed Carton	15

SCAN HERE FOR MORE PRODUCT VIDEO



# LASH 360® Tile Leveling System



- For tile or pavers up to 3/4" thick
- Posts provide 1/32", 1/16", 1/8" and 3/16" grout widths
- Save time while providing a level and consistently spaced wall or floor
- Cap design makes it easy to spin on post and tighten with wings to level tile

## Two-Part Spin System eliminates uneven tile—Post and Caps

LASH 360 ensures large format porcelain, ceramic and all natural stone tile up to 3/4" are leveled and consistently spaced during installation. The Caps are used in conjunction with the Posts to produce even grout lines and align neighboring tile delivering a lippage-free surface. For quick and easy removal, Posts are designed to break off below the surface of the tile with a simple kick in the direction of the grout line.

**No tools necessary**

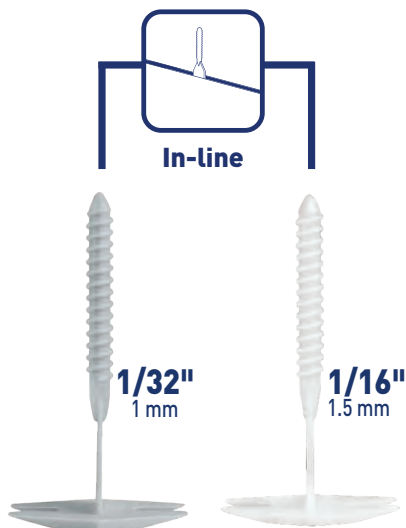

**Protection Plate**  
Recommended when using Tile Leveling Systems to protect soft tile and marble surfaces from possible scratches caused by trapped residual mortar during tightening.

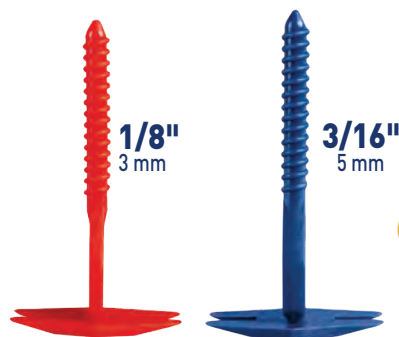

**NEW DESIGN**  
4 large wings for improved torque

Item No.	Description	Qty	Case Qty	Packaging	Pallet Qty
99738	LASH 360® 1/32" Posts	100	10	Poly Bag	40
99843	LASH 360® 1/32" Posts	300	1	Printed Carton	144
99838	LASH 360® 1/32" Posts	1000	1	Printed Carton	48
99735	LASH 360® 1/16" Posts	100	10	Poly Bag	40
99835	LASH 360® 1/16" Posts	300	1	Printed Carton	144
99837	LASH 360® 1/16" Posts	1000	1	Printed Carton	48
99739	LASH 360® 1/8" Posts	100	10	Poly Bag	40
99812	LASH 360® 1/8" Posts	300	1	Printed Carton	144
99839	LASH 360® 1/8" Posts	1000	1	Printed Carton	48
99844	LASH 360® 3/16" Posts	300	1	Printed Carton	144
99840	LASH 360® 3/16" Posts	1000	1	Printed Carton	48
99742	LASH 360® Caps	100	4	Poly Bag	40
99842	LASH 360® Caps	300	1	Printed Carton	48
99841	LASH 360® Caps	1000	1	Printed Carton	15



SCAN HERE FOR PRODUCT VIDEO

## Tile Leveling System Protection Plate

Serves as a protective buffer between the tile and the Tile Leveling System



- Protects tile surfaces from possible scratches during tightening
- No tools required for use
- Reusable after cleaning with warm water



Item No.	Description	Case Qty	Packaging
99833	Tile Leveling System Protection Plate	16	Poly Bag

## Horseshoe Shims



1/16"  
1.5 mm



1/8"  
3 mm



3/16"  
5 mm



1/4"  
6 mm



Packaged  
in reusable  
storage  
container

- Ideal for marble, granite, stone, large format tiles and vertical installations.
- Allows user to lift both corners and align the joints from tile to tile
- Non-compressive

Item No.	Description	Case Qty	Packaging
10320	1/16" Horseshoe Shims - 200 Qty	6	Tub
10321	1/8" Horseshoe Shims - 150 Qty	6	Tub
10322	3/16" Horseshoe Shims - 100 Qty	6	Tub
10323	1/4" Horseshoe Shims - 75 Qty	6	Tub

## Hard Wedge Tile Spacers



3/16"  
5 mm



Packaged  
in reusable  
storage  
container

- Ideal for wall tile installation
- Perfect for back-splash installations
- Aligns tiles in vertical installations keeping grout lines even
- Made with a high density polymer that eliminates compression

Item No.	Description	Case Qty	Packaging
10348	Hard Wedge Tile Spacer 3/16" , Jar - 500 Qty	12	Jar

## Paver Spacers



- Spacer is 2 1/2" across
- Easy to conceal- Transparent for better concealment in grass or sand installations
- Easy Installation- Easy to handle, leave in design, reduces installation time
- Versatile- for easy installation of pavers over sand, gravel and grass
- Designed with convenient break off tabs for aligning staggered pavers

Item No.	Description	Case Qty	Packaging
10451	1/8" Paver Spacers 20 pack	8	Poly Bag

## Soft Wedge Tile Spacers

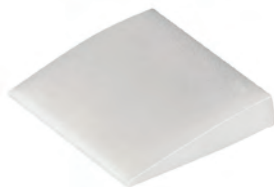

1/8"  
3 mm



- Crucial for achieving a level first row of wall tile
- Ideal for maintaining level horizontal grout lines during installation
- Avoids tile slippage on vertical surfaces - will not compress
- Can be used for up to 1/8" (3 mm)



Item No.	Description	Case Qty	Packaging
10285	Soft Wedge Tile Spacers 1/8" , Bag - 500 Qty	16	Poly Bag

## Traditional, Flexible Tile Spacers

- Works with ceramic tile, porcelain, stone and marble
- Flexible, soft plastic design for easy maneuvering in tile joints
- Evenly space tiles for uniform grout lines
- For easy removal, use spacers vertically in traditional tombstone-style



Item No.	Description	Case Qty	Packaging
10334	1/16" Tile Spacers*, Bag - 300 Qty	24	Poly Bag
10335	1/8" Tile Spacers*, Bag - 500 Qty	14	Poly Bag
10336	3/16" Tile Spacers*, Bag - 300 Qty	14	Poly Bag
10005	1/4" Tile Spacers*, Bag - 200 Qty	15	Poly Bag
10027	3/8" Tile Spacers*, Bag - 100 Qty	20	Poly Bag

**\*Not recommended for large format wall tiles over 15"**

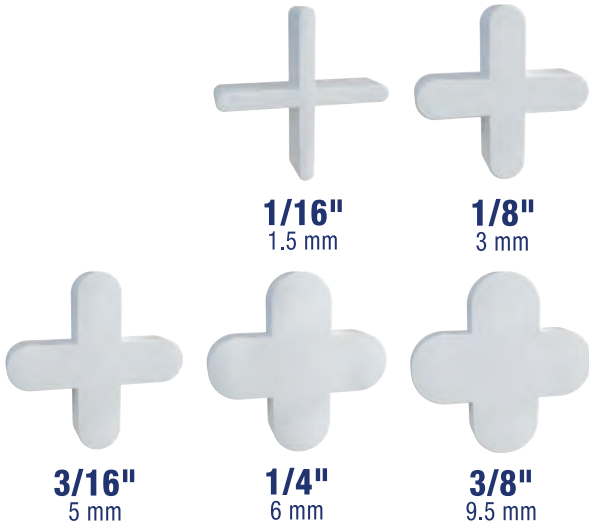

## "T" Tile Spacers

- For aligning all floor and wall tiles
- For Subway, brick layout or offset tiling patterns and perimeters
- Will not compress when setting marble, granite, stone and large format tile
- Use in traditional "tombstone" style or leave between tiles and grout over
- Support bar and extended solid tip for improved tile support, keeping the spacer from compressing
- Longer leg length for easier installation

Item No.	Description	Case Qty	Packaging
10202	1/16" "T" Tile Spacers, Bag - 300 Qty	24	Poly Bag
10203	1/8" "T" Tile Spacers, Bag - 300 Qty	20	Poly Bag
10204	3/16" "T" Tile Spacers, Bag - 200 Qty	14	Poly Bag

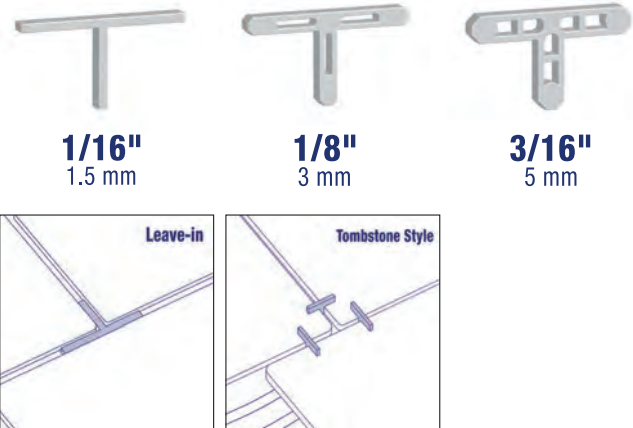

## Hard, Leave-in Tile Spacers

- Will not compress when setting marble, granite, stone and large format tile
- Use as traditional vertical tombstone-style or inset leave-in installation method
- Leave-In design reduces installation time
- Easy to handle, extra long prongs assure perfect 90° grout corners



Item No.	Description	Case Qty	Packaging
10330-20	1/16" Leave-In Spacers, Bag - 300 Qty	20	Poly Bag
10331-18	1/8" Leave-In Spacers, Bag - 300 Qty	18	Poly Bag
10332	3/16" Leave-In Spacers, Bag - 200 Qty	12	Poly Bag
10333	1/4" Leave-In Spacers, Bag - 200 Qty	10	Poly Bag
10324	1/16" Leave-In Spacers, Jar - 1500 Qty	6	Jar
10325	1/8" Leave-In Spacers, Jar - 1000 Qty	6	Jar
10326	3/16" Tile Spacers, Jar - 500 Qty	6	Jar

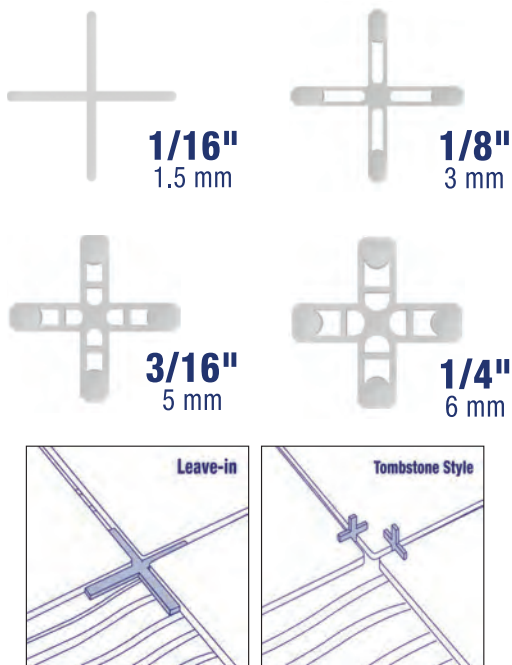



## TROWELS & FLOATS

QEP boasts an extensive offering of Trowels and Floats. With a variety of grips, sizes and designs, QEP makes it easy to find the right products for your tile installation project. Favorites of professional installers include the QEP Xtreme Pro Series Cork Handle Notched Trowels, QEP Margin Trowels and Floats, which feature bucket hooks for easy storage, and the QEP Extreme Pro Series Stone Grout Float, shaped to contour and flex giving you the leverage you need.



# EURO NOTCH CORK HANDLE TROWEL



Alternating notch pattern delivers a uniform mortar bed, minimizing voids.

Its "zipper effect" locks the subfloor, thinset, and tile together, eliminating air pockets for a stronger, longer-lasting bond.

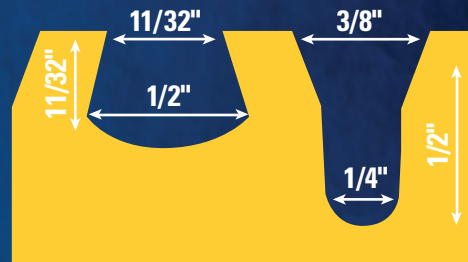

**NEW**

# SLANT NOTCH CORK HANDLE TROWEL



Slanted notches deliver superior thinset transfer and reduces voids for stronger tile adhesion.

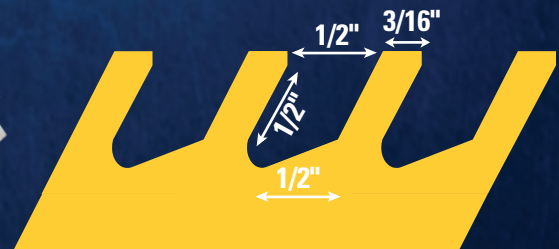

Recommended for all large-format tile installations per the NTCA Reference Manual

Longest lasting blades in the industry.



# X-TREME PRO-SERIES Cork Handle Stainless Steel Trowels



- Cork comfort grip for better cushion and anti-slippage in the hand
- 25% longer shank with 13 exposed, reinforced rivets for superior strength
- Extra handle-to-shank distance allows maximum hand clearance
- Rust resistant 12" x 4½" durable stainless steel blade lasts 25% longer

**NEW**

Item No.	Description	Case Qty	Packaging
49950-12	Xtreme Cork Handle Trowel Square Notch 1/4" x 1/4" x 1/4"	12	Shelf Case
49951-12	Xtreme Cork Handle Trowel Square Notch 1/4" x 3/8" x 1/4"	12	Shelf Case
49952-12	Xtreme Cork Handle Trowel Square Notch 1/2" x 1/2" x 1/2"	12	Shelf Case
49956-12	Xtreme Cork Handle Trowel Euro Notch (available in Canada)	12	Shelf Case
49957-12	Xtreme Cork Handle Trowel Slant Notch	12	Shelf Case
<b>QEP Canada Only</b>			
49953-12	Xtreme Cork Handle Trowel with ruler Square Notch 1/4" x 1/4" x 1/4"	12	Shelf Case
49954-12	Xtreme Cork Handle Trowel with ruler Square Notch 1/4" x 3/8" x 1/4"	12	Shelf Case
49955-12	Xtreme Cork Handle Trowel with ruler Square Notch 1/2" x 1/2" x 1/2"	12	Shelf Case

# Comfort Grip Stainless Steel Trowels



- Large, contoured and cushioned grip handle for comfort
- Nine-rivet shank with reinforced end rivets for enhanced durability
- Extra handle-to-shank distance allows maximum hand clearance
- Rust resistant 11" x 4½" durable stainless steel blade lasts 25% longer

**NEW**

Item No.	Description	Case Qty	Packaging
49915-12	Comfort Grip Stainless Steel Trowel Square Notch 1/4" x 1/4" x 1/4"	12	Shelf Case
49916-12	Comfort Grip Stainless Steel Trowel Square Notch 1/4" x 3/8" x 1/4"	12	Shelf Case
49917-12	Comfort Grip Stainless Steel Trowel V Notch 3/16" x 5/32"	12	Shelf Case
49918-12	Comfort Grip Stainless Steel Trowel Euro Notch (available in Canada)	12	Shelf Case
49919-12	Comfort Grip Stainless Steel Trowel Square Notch 1/2" x 1/2" x 1/2"	12	Shelf Case
49920-12	Comfort Grip Stainless Steel Trowel Slant Notch	12	Shelf Case



# Wood Handle Trowels



- Large wooden handle for an easy grip
- Aluminum die-cast shank

Item No.	Description	Case Qty	Packaging
49713	Wood Handle Trowel Square Notch 1/4" x 1/4" x 1/4"	12	Shelf Case
49714	Wood Handle Trowel Square Notch 1/4" x 3/8" x 1/4"	12	Shelf Case
49716	Wood Handle Trowel V Notch 1/4" x 3/16"	12	Shelf Case
49720	Wood Handle Trowel Square Notch 1/2" x 1/2" x 1/2"	12	Shelf Case

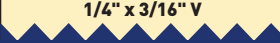
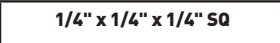
# Notched Trowels at a glance

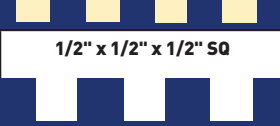
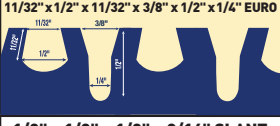
Notch Size	Application	<b>X-TREME</b> Cork Handle (12" Blade)	Comfort Grip (11" Blade)	Wood Handle (11" Blade)	Standard (9" Blade)
<b>3/16" x 5/32" V</b> 	For plastic, wall, ceramic & metal tile 6" x 6" or smaller and mosaics on drywall. Also for wall base.		49917-12		10115
<b>1/4" x 3/16" V</b> 	For ceramic, metal & aluminum wall tile 6" x 6" up to 12" x 12"			49716	10116 Canada Only
<b>1/4" x 1/4" x 1/4" SQ</b> 	For thinset application of ceramic tile 8" x 8" or smaller, laminated wood plank flooring, flat milled solid & shorts or plywood	49950-12 49953-12 Canada Only	49915-12	49713	10113
<b>1/4" x 3/8" x 1/4" SQ</b> 	Thinset application of ceramic tile 8" x 8" up to 16" x 16"	49951-12 49954-12 Canada Only	49916-12	49714	10114
<b>1/2" x 1/2" x 1/2" SQ</b> 	Thinset or medium bed mortar application of natural stone, quarry tile, pavers, saltillo and ceramic tiles 12" x 12" and larger	49952-12 49955-12 Canada Only	49919-12	49720	10120
<b>11/32" x 1/2" x 11/32" x 3/8" x 1/2" x 1/4" EURO</b> 	Thinset or medium bed mortar application of natural stone, quarry tile, pavers, saltillo and ceramic tiles 12" x 12" or larger.	49956-12	49918-12		
<b>1/2" x 1/2" x 1/2" x 3/16" SLANT</b> 	Thinset or medium bed mortar application of natural stone, quarry tile, pavers, saltillo and ceramic tiles 12" x 12" or larger.	49957-12	49920-12		

Always check adhesive/mortar manufacturer's trowel recommendations before selecting a trowel notch.

All Trowels Measure:  
Width x Depth x Space Apart

Recommended notch sizes by NTCA  
(National Tile Contractors Association)

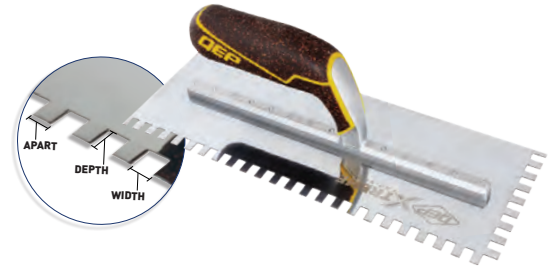

# Standard Trowels

- Quality trowel measuring 9" x 4"
- Hard, cold-rolled steel blade for longer wear
- High-impact black plastic handle



Item No.	Description	Case Qty	Packaging
10113	Standard Trowel Square Notch 1/4" x 1/4" x 1/4"	30	Shelf Case
10114	Standard Trowel Square Notch 1/4" x 3/8" x 1/4"	30	Shelf Case
10115	Standard Trowel V Notch 3/16" x 5/32"	30	Shelf Case
10120	Standard Trowel Square Notch 1/2" x 1/2" x 1/2"	30	Shelf Case
<b>QEP Canada Only</b>			
10116	Standard Trowel V Notch 1/4" x 3/16"	30	Shelf Case

# Patch & Finishing Trowel

- For leveling, patching and finishing
- Hardened, tempered, ground and polished steel blade
- Die-cast aluminum shank with wood handle



Item No.	Description	Case Qty	Packaging
49708	Patch & Finishing Trowel 11" x 4-1/2" No Notch	12	Shelf Case

## Margin Trowel



**BUCKET HOOK**



- Enlarged 6" x 2" blade is made from ground, tempered and hardened steel for flexibility and durability
- Patent pending bucket hook for easy storage on the side of your bucket
- Co-molded plastic handle with non-slip, rubber grip for comfortable repeat use

Item No.	Description	Case Qty	Packaging
42112	6" x 2" Comfort Grip Margin Trowel No Notch	12	Shelf Case
42114	6" x 2" Comfort Grip Margin Trowel Square Notch 1/4" x 1/4" x 1/4"	12	Shelf Case

## Bucket Scoop



**BUCKET HOOK**

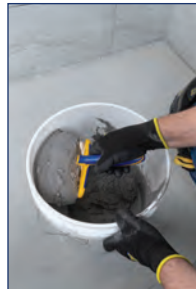

- New Design! Scoops all setting material from sides and bottom of 4 or 5 gallon bucket
- Patent pending bucket hook for easy storage on the side of your bucket
- Improved contoured cushion handle provides better angle and flexibility
- Stainless steel blade

Item No.	Description	Case Qty	Packaging
42113-6	Bucket Scoop	6	Hang Card

## Margin Float



**BUCKET HOOK**



- Ideal for hard-to-reach areas such as kitchen backsplashes or under bath and kitchen counters
- Patent pending bucket hook for easy storage on the side of your bucket
- Enlarged 6" x 2" gum rubber pad with tempered and hardened steel backing plate
- Co-molded plastic handle with non-slip, rubber grip

Item No.	Description	Case Qty	Packaging
42117	6" Comfort Grip Margin Float	12	Shelf Case

# **X-TREME** Stone Grout Float

For all grout types, including epoxy

- Soft body design provides maximum flex and leverage for working grout into tile joints, with sanded and non-sanded grouts, for textured tile and natural stone
- Inner aluminum backing plate offers strength and stability
- Squared corners ensure complete coverage in corners



Maximum flex for all grout types

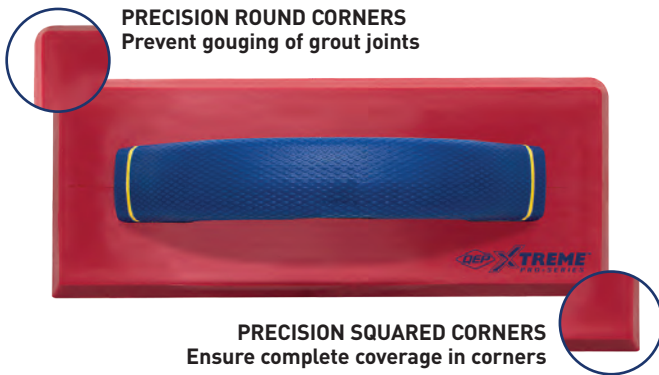

**PRECISION ROUND CORNERS**  
Prevent gouging of grout joints

**PRECISION SQUARED CORNERS**  
Ensure complete coverage in corners

Item No.	Description	Case Qty	Packaging
10069	Xtreme Stone Grout Float, 10" x 4"	12	Shelf Case

**SCAN HERE** FOR MORE PRODUCT INFORMATION



# Universal Float

- Non-stick gum rubber ensures smooth application for all grout types including epoxy
- 2-rounded corners prevent gouging of grout joints
- 2-square corners ensure complete grout coverage in corners
- Extra thick aluminum backing plate for maximum leverage and applying grout into joints.
- Comfortable, contoured and cushioned grip handle

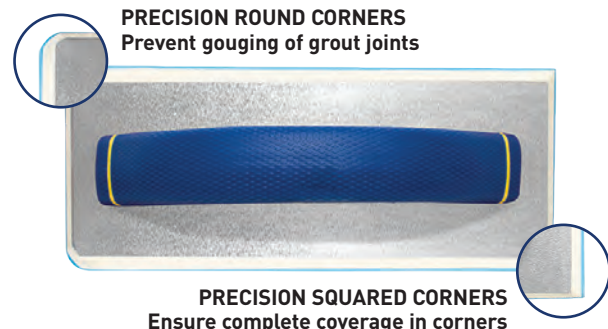
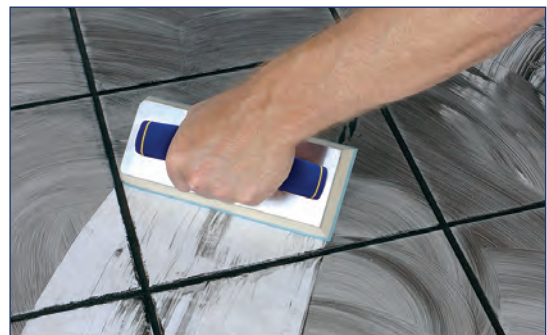
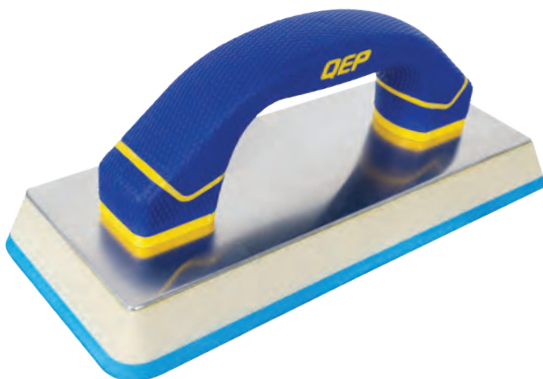

**PRECISION ROUND CORNERS**  
Prevent gouging of grout joints

**PRECISION SQUARED CORNERS**  
Ensure complete coverage in corners

Item No.	Description	Case Qty	Packaging
10074-8	Universal Float 9-1/2" x 4"	8	Shelf Case

## Gum Rubber Grout Float



- Non-stick gum rubber ensures even application and maximum removal
- 2-rounded corners prevent gouging of grout joints
- 2-square corners ensure complete grout coverage in corners
- Extra thick aluminum backing plate for maximum leverage and applying grout into joints
- Premium gum rubber laminated to lightweight, closed cell core is built to last



Item No.	Description	Case Qty	Packaging
10070	Gum Rubber Grout Float, Wood Handle, 10½" x 4"	12	Shelf Case

## Molded Rubber Grout Float



- Non-stick 5/8" molded gum rubber pad prevents absorption of materials
- Aluminum back plate for durability and beveled sides for a smooth application



Item No.	Description	Case Qty	Packaging
10060	Molded Rubber Grout Float 9½" x 4"	12	Shelf Case

## Grout Float



- High-impact plastic handle with closed cell foam rubber pad for a smooth application



Item No.	Description	Case Qty	Packaging
10062	Grout Float 9" x 4"	24	Shelf Case



## DIAMOND TOOLS

QEP Diamond tools are manufactured using a state-of-the-art brazed diamond bonding process to deliver consistent performance on even the toughest of porcelain.

Using the highest-quality industrial diamonds, our superior coating process allows for precise application of diamond grit, ensuring cleaner and more accurate holes and cuts.

Our thin and precise diamond grit edges are optimized for long life and fast cutting with cordless tools.

# **X-TREME** PRO-SERIES Diamond Hole Saws for Drills

- Advanced metallurgical technology bonds diamond grit to chrome alloy steel base to produce a long lasting cutting edge
- Extremely durable and built to last longer than conventional diamond drill bits and standard hole saws
- Simply dip in water, no need for a constant water delivery system, for quick and easy use
- Fits standard 3/8" or 1/2" drill chucks

up to  
**12X**  
LONGER LIFE  
than standard hole saws



3/16"      1/4"      5/16"      1-3/8"



Item No.	Description	Case Qty	Packaging
10071	Xtreme 3/16" Diamond Hole Saw	6	Hang Card
10075	Xtreme 1/4" Diamond Hole Saw	6	Hang Card
10075-8	Xtreme 1/4" Diamond Hole Saw 8 pk	6	Carton
10080	Xtreme 5/16" Diamond Hole Saw	6	Hang Card
10080-8	Xtreme 5/16" Diamond Hole Saw 8 pk	6	Carton
10087	Xtreme 1-3/8" Diamond Hole Saw	6	Hang Card
10087-8	Xtreme 1-3/8" Diamond Hole Saw 8 pk	6	Carton



SCAN HERE FOR MORE PRODUCT INFORMATION

# **X-TREME** PRO-SERIES wax/DRY Diamond Hole Saw Kit

- Convenient kit contains 4 size: 1/4", 5/16", 3/8" & 1/2" (6 mm, 8 mm, 10 mm, 12 mm)
- Ideal for placing bathroom accessories or any type of decoration accessory on ceramic surfaces
- Simply dip in water, no need for a constant water delivery system, for quick and easy use
- Wax lubricant for cooling the diamond edge

up to  
**12X**  
LONGER LIFE  
than standard hole saws

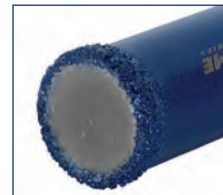

1/4"      5/16"      3/8"      1/2"



Item No.	Description	Case Qty	Packaging
10485	Xtreme wax/DRY Diamond Hole Saw Kit	6	Hang Card



SCAN HERE FOR MORE PRODUCT INFORMATION

# **X-TREME** PRO-SERIES Diamond Hole Saws for Angle Grinders



- Last at least 12x longer than drill attachment
- Superior brazing technology ensures diamonds stay bonded
- Simply dip in water, no need for a constant water delivery system, for quick and easy use
- Wax lubricant for cooling the diamond edge (3/16", 1/4", 5/16" sizes)



up to  
**50%  
FASTER**  
THAN A DRILL

Item No.	Description	Case Qty	Packaging
10468	Xtreme 3/16" Hole Saw for grinder	6	Hang Card
10469	Xtreme 1/4" Hole Saw for grinder	6	Hang Card
10470	Xtreme 5/16" Hole Saw for grinder	6	Hang Card
10471	Xtreme 1" Hole Saw for grinder	6	Hang Card
10472	Xtreme 1-3/8" Hole Saw for grinder	6	Hang Card
10473	Xtreme 2" Hole Saw for grinder	6	Hang Card
10474	Xtreme 2-1/2" Hole Saw for grinder	6	Hang Card
10475	Xtreme 4" Hole Saw for grinder	6	Hang Card



SCAN HERE FOR MORE PRODUCT INFORMATION

# **X-TREME** PRO-SERIES Diamond Undercut & Grout Remover Blade



- Diamond grit technology
- Fast grout removal
- No adapter is required
- Open-LOK anchor for fast blade changes



up to  
**12X**  
**LONGER LIFE**  
than standard hole saws

Item No.	Description	Case Qty	Packaging
10088	Diamond grit grout removal curved blade	6	Hang Card
10089	Diamond grit grout removal linear blade	6	Hang Card



SCAN HERE FOR MORE PRODUCT INFORMATION

# XTREME<sup>™</sup> PRO-SERIES Diamond Milling Bits & Cones



- Special diamond grit surface for faster and smoother milling of porcelain, hard ceramic, granite and marble
- Works on all standard grinders
- No adaptor necessary



Item No.	Description	Case Qty	Packaging
10051	Xtreme 3/8" Diamond Milling Bit	6	Hang Card
10052	Xtreme 3/4" Diamond Milling Bit	6	Hang Card
10066	Xtreme 1-1/2" Diamond Milling Cone	6	Hang Card



SCAN HERE FOR MORE PRODUCT INFORMATION

## Diamond Sanding Blocks

- Smooth tile, stone, granite, glass, ceramic, and marble
- Manufactured with superior brazed diamond bonding and a lightweight foam base
- Flexible and easy to use in hard to reach places, corners, and edges
- Can be used wet or dry for finishing cut tile to a factory finish

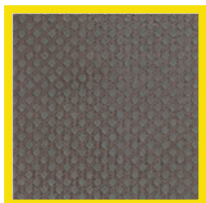
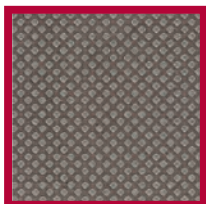
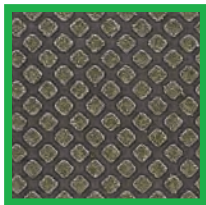

Grit	Purpose
60	Aggressive coarse grit for high rough spots
120	Medium grit for smoothing
200	Fine grit for smoothing
400	Smooth for polishing



Item No.	Description	Case Qty	Packaging
10046	60 Grit Sanding Block	6	Hang Card
10047	120 Grit Sanding Block	6	Hang Card
10048	200 Grit Sanding Block	6	Hang Card
10049	400 Grit Sanding Block	6	Hang Card



SCAN HERE FOR MORE PRODUCT INFORMATION

# X-TREME PRO-SERIES 4" Dry Polishing Pads

**NEW**

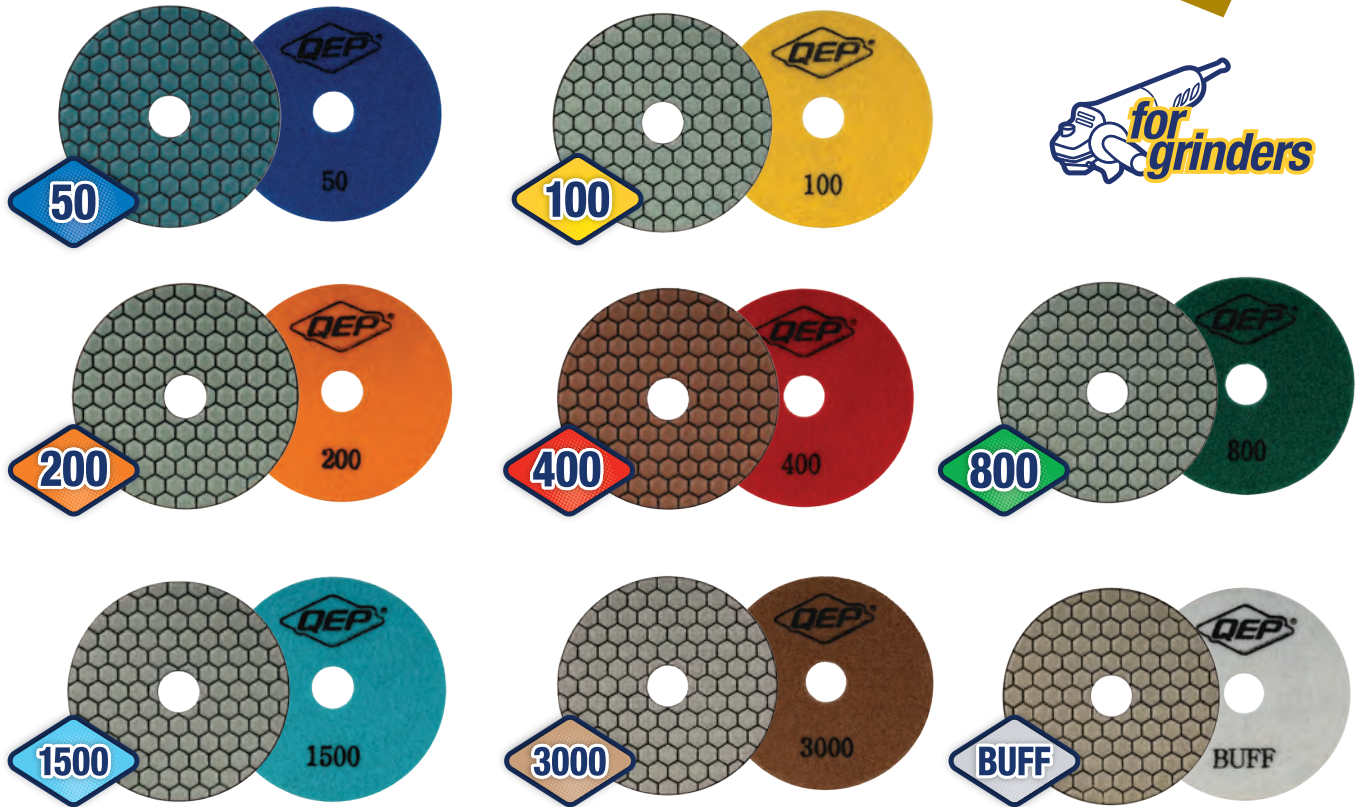

**for grinders**

## 4" Dry Polishing Pads

- Wide Application: Ideal for polishing ceramic, porcelain, engineered stone, concrete, marble or granite
- Diamond Ceramic Bond provides higher abrasion resistance for long term use
- Hook and Loop backing for quick and secure attachment to the backing pad



# X-TREME PRO-SERIES 4" Backing Pad

**NEW**



**Backing Pad**  
10156

## Rubber Backing Pad

- Quick & Secure Attachment: Hook and Loop backing ensures fast, hassle-free connection to the polishing pad
- Universal Fit:  $\frac{5}{8}$ "-11 threading and compatible with Hook and Loop backed polishing pads
- Backing pad easily locks onto your grinder for smooth, uninterrupted performance

**for grinders**



Item No.	Description	Case Qty	Packaging
10156	4" Rubber Backing Pad	4	Hang Card



Grit	Purpose
50	Heavy material removal, flattening uneven surfaces
100	Removes deep scratches left by 50 grit
200	Further smooths the surface, reducing visible scratches
400	Starts refining the surface for a semi-smooth finish
800	Pre-polishing stage, brings out slight sheen
1500	Polishing stage, creates a smooth reflective finish
3000	High-gloss polishing, near mirror finish
BUFF	Final buffing for maximum shine



## 4" DRY POLISHING PADS 4PC SET

includes 3 Pads & 1 Buffer

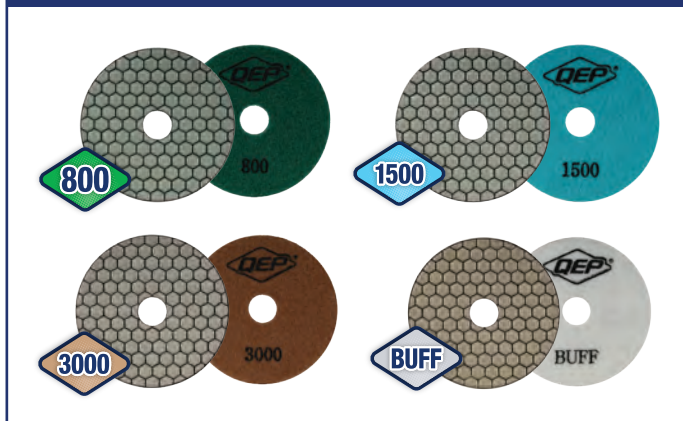

Item No.	Description	Case Qty	Packaging
10152	50 Grit 4" Dry Polishing Pad	4	Hang Card
10153	100 Grit 4" Dry Polishing Pad	4	Hang Card
10154	200 Grit 4" Dry Polishing Pad	4	Hang Card
10155	400 Grit 4" Dry Polishing Pad	4	Hang Card
10158	800 Grit 4" Dry Polishing Pad	4	Hang Card
10159	1500 Grit 4" Dry Polishing Pad	4	Hang Card
10161	3000 Grit 4" Dry Polishing Pad	4	Hang Card
10162	Buff Polishing Pad	4	Hang Card
10157	4 Piece Polishing Pad Set	4	Hang Card

## 3" Diamond Jigsaw Blade



- For cutting hard materials, including porcelain and ceramic tile
- Cuts faster and cleaner than standard carbide blades
- Heat treated alloy steel backer for superior strength



SUPERIOR BRAZED  
DIAMOND BONDING

Item No.	Description	Case Qty	Packaging
10585	3" Diamond Jigsaw Blade	6	Hang Card

## Diamond Hole Saw with Water Delivery System

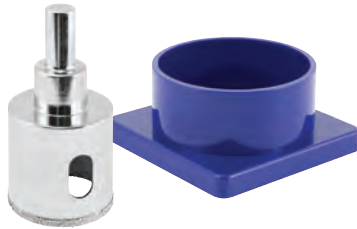

- For cutting 1 3/8" diameter holes in glass, ceramic, porcelain, marble and granite
- Special diamond grit edge for faster smoother cuts
- Included drill guide and water cooling cup easily supplies water to drill bit (use wet-only)
- Fits standard 1/2" or 3/8" drill chucks
- Includes 6 adhesive strips, water cooling cup and 1 3/8" diameter x 3" tall drill bit
- Only for wet use with cordless drills

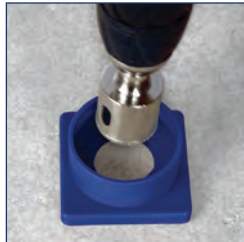

SUPERIOR BRAZED  
DIAMOND BONDING



Item No.	Description	Case Qty	Packaging
10569	1-3/8" Porcelain Diamond Hole Saw w/Drill Guide and Water Cooling System	6	Hang Card
10570	1-3/8" Hole Saw Extra Mounting Tape	6/cs (12 pc/bag)	Hang Card

## Grind Shield



3-Pack

- Protects surfaces against chipping and burn marks
- 5/8" - 11 thread size (fits standard grinders)
- Impact resistant plastic construction
- Perfect for tricky angles and tight corners
- Universal opening for easy spanner wrench adjustments



Item No.	Description	Case Qty	Packaging
10476	Grind Shield - 3 Pack	6	Hang Card

## Diamond Grit File



- The high quality diamond bond strength maintains a tough grit surface for working with the hardest materials, including ceramic, porcelain, glass and stone
- Can also be used to smooth other materials, including fiberglass, laminate flooring, cement board and carbon fiber
- Flat/round profiles allow for smoothing both straight and curved edges
- Co-molded plastic handle with non-slip, rubber grip for comfortable repeat use



SUPERIOR BRAZED  
DIAMOND BONDING

Item No.	Description	Case Qty	Packaging
10586-6	Diamond Grit File	6	Hang Card

## Pro Grout Saw



- Curved heavy duty carbide blades easily remove stubborn grout
- Blade storage in handle can hold up to 2 blades
- Use 1 blade for thinner grout lines and 2 blades for wider grout lines



SUPERIOR BRAZED  
DIAMOND BONDING

Item No.	Description	Case Qty	Packaging
10093	Pro Grout Saw	6	Hang Card
75011	Replacement Grout Saw Blades 2 pack	6	Hang Card

## Grout Saw



- Strips, cleans and removes old grout, may be used on all grout types
- Includes 1 steel tooth blade for removing tough grout and 1 carbide grit blade for finishing and fine removal
- Use both blades for wide grout lines



SUPERIOR BRAZED  
DIAMOND BONDING

Item No.	Description	Case Qty	Packaging
10057	Grout Saw	12	Hang Card
75011	Replacement Grout Saw Blades 2 pack	6	Hang Card

## Grout Saw Blades



**2-Pack**

- Replacement blades for the Pro Grout Saw and the Grout Saw 10093, 10093C, 10057, 10057C



SUPERIOR BRAZED  
DIAMOND BONDING

Item No.	Description	Case Qty	Packaging
75011	Replacement Grout Saw Blades 2 pack	6	Hang Card



# INSTALLATION & BACKERBOARD TOOLS

Nippers, Mixers, Suction Cups, Specialty Tools, Grout Removers, Mallets, Knives, Tape, Sponges, Gloves, and more is what you will find in our Installation and Backerboard Tool assortment!

Introducing **X-TREME**  
PRO-SERIES

# ARTISAN

## POWER NIPPER

**NEW**

Designed in collaboration with  
Mosaic Artist David Arnott



Offset 5/8" titanium coated tungsten carbide tips provide cleaner edges & smoother cuts

Three cut settings  
5 mm, 10 mm & 13 mm

Wide offset jaw  
allows for unlimited  
depth of cut

Gel grip.  
Zero slip.  
Total control.

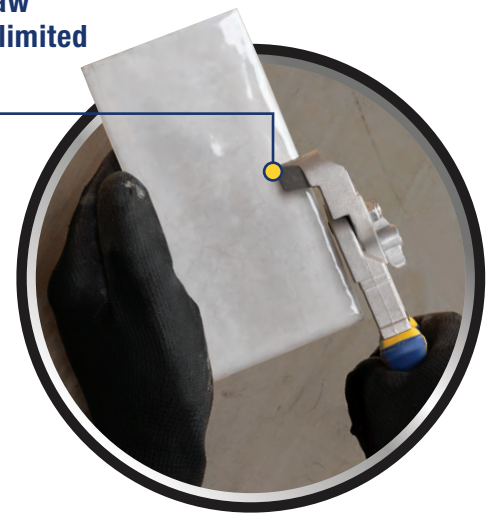

- Offset 5/8" titanium coated tungsten carbide tips for cleaner edges and smoother cuts
- Adjustable cut settings 5mm, 10mm and 13 mm
- Gel Grip for comfort and control
- Internal bumpers and steel spring for cushioned impact
- Precision cutting across all tile, glass tile and porcelain

Item No.	Description	Case Qty	Packaging
32016	Xtreme Artisan Power Tile Nipper	6	Hang Card

SCAN HERE FOR  
PRODUCT INFO



## Compound Tile Nipper



- Compound mechanism delivers 3 times more force with less effort
- Use to cut irregular shapes in all tile from 1/8" to 1/4" thick
- Durable tungsten carbide tip provides a long cutting life
- Co-molded plastic handle with non-slip, rubber grip for comfortable repeat use

Item No.	Description	Case Qty	Packaging
32036	Compound Tile Nipper	6	Hang Card

## Tile Nipper



- 8" carbide tipped nippers with offset jaws
- For cutting irregular shapes in tile from 1/8" to 1/4" thick
- Single piece, drop-forged steel construction for maximum strength

Item No.	Description	Case Qty	Packaging
10003	Tile Nipper	12	Hang Card

## Tile Cutter



- Recommended for manually scoring and cutting ceramic wall tiles up to 6" x 6" and 1/4" thick
- Uses a durable tungsten carbide wheel for scoring and a breaker bar to "snap" ceramic tile

Item No.	Description	Case Qty	Packaging
32024	Tile Cutter	6	Hang Card

## 6" Locking Contour Gauge



- Easily forms around any shape for a precise template, reducing waste created when guessing the dimension of irregular shapes
- Locking feature holds patterns in place while tracing on any surface
- Great for marking precise cutouts in vinyl, wood, porcelain and ceramic tiles

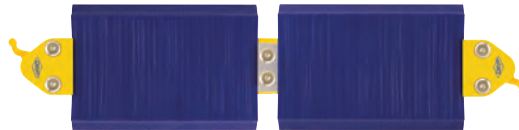

Combine 2 Gauges for longer profiles

Item No.	Description	Case Qty	Packaging
10038	6" Locking Contour Gauge	1	Hang Card

## Wax China Markers



- Premium markers made with a superior wax blend for seamless writing on both non-porous and most porous surfaces.
- Perfect for porcelain, glass, ceramics or polished stone
- Resistant to moisture, and markings wipe off easily, making it an ideal choice for a variety of projects
- Easy-tear string, no need for sharpening



Item No.	Description	Case Qty	Packaging
38779	Wax China Markers - 2 Pack - 1 black/1 red	12	Hang Card

## Rubbing Stone



- Dual grit surfaces smooth rough edges on freshly cut ceramic & porcelain tile, stone, marble and brick
- Medium 60-grit on one side and fine 80-grit on the other
- Ideal for dressing diamond blades by exposing fresh diamonds in the blade rim

Item No.	Description	Case Qty	Packaging
10022	Rubbing Stone 6" x 2" x 1"	6	Hang Card

# Power Mixer Pro

- High torque powerful 1400 Watt motor
- 0-800 RPM variable speed dial to prevent initial splash
- Lock-on function keeps mixer at desired RPM without holding the trigger
- Double insulated motor for splash protection and a durable, cast aluminum gear box
- 24 in. long paddle with a 5½ in. wide blade and ½ in. shaft diameter



0-800 RPM variable speed dial

Includes ½" Chuck Kit



## SPECIFICATIONS

Item No	21700
Motor	120 V ~ 1400 Watts 1st gear: 0-480 RPM 2nd gear: 0-800RPM
Amps	12½
Weight	10½ lbs.

Item No.	Description	Case Qty	Packaging
21700	Power Mixer Pro w/ Paddle	1	Color Carton
21661	24" Pro Mixing Paddle (Replacement)	1	Shelf Case



SCAN HERE FOR MORE PRODUCT INFORMATION

## 30" XL Spiral Pro Mixing Paddle

Designed to reduce air in mixture

30-inch shaft preferred by pros for reducing back strain during mixing.



Item No.	Description	Blade Width	Case Qty	Packaging
61230	30" XL Spiral Pro Mixer	5½"	6	Shelf Case

## 24" Pro Mixing Paddle

Replacement paddle for QEP Power Mixer Pro 21700 or any mixer that accepts M-14 thread



Item No.	Description	Blade Width	Case Qty	Packaging
21661	24" Pro Mixing Paddle	5½"	1	Shelf Case

## 24" Pro Mixing Paddle

24-inch length with 5-inch blade

Available in 30 count floor displays  
61205D see page 89



Item No.	Description	Blade Width	Case Qty	Packaging
61205	24" Pro Mixing Paddle	4-7/8"	8	Shelf Case
61205D	24" Pro Mixing Paddle Display	4-7/8"	30	Floor Display

## 23½" Thinset and Grout Mixing Paddle

8¼ in. wide blade and ⅜ in. shaft diameter



Item No.	Description	Blade Width	Case Qty	Packaging
75001Q	23½" Thinset and Grout Mixing Paddle	8¼"	6	Shelf Case

## 16" Universal Mixing Paddle

Fits in 1 Gallon Bucket

16-inch universal paddle is ideal for mixing small batches of thinset, grout, mortar, cement, or plaster



Item No.	Description	Blade Width	Case Qty	Packaging
61210	16" Universal Mixing Paddle	3½"	12	Shelf Case

# XTREME PRO-SERIES 8" Electric Suction Cup



- Built in air sensor provides steady suction with 48 hour non-stop running time
- Multi-layered sealed safety rim
- Digital LED display indicating battery life
- Rechargeable Lithium-ion battery (6-8 hours charging time)
- USB-C charging cable and durable carrying case



Item No.	Description	Case Qty	Packaging
75024	Xtreme Pro Series 8" Electric Suction Cup	3	Carton

⚠️WARNING: Cancer and Reproductive Harm- www.P65Warnings.ca.gov. See P. 89, \*Prop 65 - 1.



SCAN HERE FOR PRODUCT VIDEO

# 8" Pump Suction Cup with Gauge



- Hand held, portable tool for lifting large tiles, glass, and more
- Red line indicator shows when to engage suction
- Safety gauge to monitor suction
- Anti-slip sealed safety rim



Item No.	Description	Case Qty	Packaging
75022	8" Pump Suction Cup with Gauge	3	Carton

⚠️WARNING: Cancer and Reproductive Harm- www.P65Warnings.ca.gov. See P. 89, \*Prop 65 - 1.



SCAN HERE FOR MORE PRODUCT INFORMATION

# 8" Vacuum Pump Suction Cup



- Hand held, portable tool for lifting large tiles, glass, and more
- Red line indicator shows when to engage suction
- Sealed safety rim line



Item No.	Description	Case Qty	Packaging
75021	8" Vacuum Pump Suction Cup	3	Carton

⚠️WARNING: Cancer and Reproductive Harm- www.P65Warnings.ca.gov. See P. 89, \*Prop 65 - 1.



SCAN HERE FOR MORE PRODUCT INFORMATION



## Rough Surfaces Double Suction Cup

**NEW**



- Grips rough textured surfaces
- Stain-free 4<sup>3/8</sup>" non marring rubber pads
- Quick-release levers for rapid and secure coupling and decoupling
- Ideal for handling tile, glass, marble, granite, sheet metal, and other flat materials



Item No.	Description	Case Qty	Packaging
75018	Xtreme Rough Surfaces Double Suction Cup	3	Shelf Case

⚠️WARNING: Cancer and Reproductive Harm- www.P65Warnings.ca.gov. See P. 89, \*Prop 65 - 1.



## Rough Surfaces Single Suction Cup

**NEW**



- Grips rough textured surfaces
- Single action grip and release
- Stain-free 4<sup>3/8</sup>" non marring rubber pad
- Ideal for handling tile with texture, glass, marble, and granite



Item No.	Description	Case Qty	Packaging
75019	Xtreme Rough Surfaces Single Suction Cup	6	Shelf Case

⚠️WARNING: Cancer and Reproductive Harm- www.P65Warnings.ca.gov. See P. 89, \*Prop 65 - 1.

## ProMAXGrip® Double Suction Cup



- For use on clean, non-porous large format tile and marble
- Dual action suction and release system
- Simple single hand operation
- Strong, textured, non-slip grip



Item No.	Description	Case Qty	Packaging
75013	ProMAX® Grip Double Suction Cup	3	Shelf Case

## Double Suction Cup



- Maximum vacuum hold to move smooth, non-porous tile and cultured marble
- Heavy duty, aluminum frame



Item No.	Description	Case Qty	Packaging
75003	Double Suction Cup	3	Shelf Case

## Suction Cup



- For easy handling of non-porous tile, marble and glass during installation
- Suction cup pad is 4½" in diameter
- 3½" wide handle opening easily accommodates large hands



Item No.	Description	Case Qty	Packaging
75000	Suction Cup	6	Shelf Case

## Grout Remover



- For removing unwanted grout, mortar, thinset, calcium, caulking and surface rust
- Double-sided head with 3 durable carbide tips
- Includes 1/16", 1/8" and 3/16" tips for different grout line widths

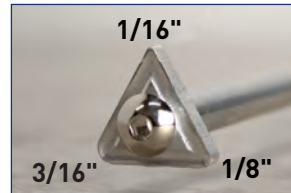

Item No.	Description	Case Qty	Packaging
10020	Grout Remover	12	Hang Card

## Thinset Removal Tool

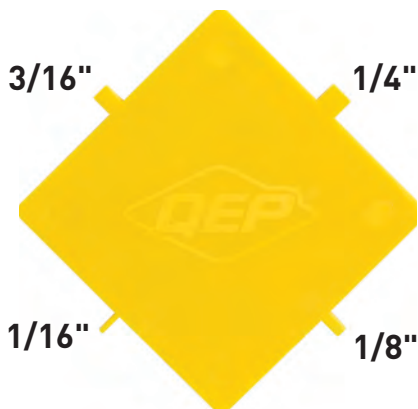

- For removing excess thinset between tiles, during installation
- Durable, easy to clean and will not scratch tile
- Clearly marked tips for most popular grout joints 1/16", 1/8", 3/16" and 1/4"
- Patent pending 4-in-1 flat, compact tool for easy storage and portability

Item No.	Description	Case Qty	Packaging
62963	Thinset Removal Tool	10	Hang Card

## Grout Sealer Applicator



Roller



Brush

- Includes (2) roller wheels for multiple grout widths:
  - Use 1/8" wheel for grout joints 1/8" and smaller
  - Use 1/4" wheel for grout joints 1/4" and larger
- Works with all grout sealers
- Patented roller wheel system provides complete coverage
- Holds 12 oz. (355 ml)

Item No.	Description	Case Qty	Packaging
10279	Grout Sealer Applicator	12	Hang Tab

- Great for small projects with narrow grout joints
- Works with all grout sealers
- Plastic bottle holds up to 4 oz. of grout sealer

Item No.	Description	Case Qty	Packaging
19999	Grout Sealer Brush Applicator	12	Hang Tab

## Grout Bag



- Reinforced tip for smooth application and long life
- Protects hands from grout and other harsh substances
- Made of puncture and tear resistant coated vinyl

Item No.	Description	Case Qty	Packaging
76000	Grout Bag	12	Shelf Case

## Multi-Use Trim Shears



- Easily cuts quarter round, tile trim, PVC piping, tackstrip and other light materials
- Makes fast angle cuts in wood quarter round, tile trim, PVC piping, tackstrip and other materials
- Eliminates the need for a chop or miter saw
- Miter guide is clearly marked at 45°, 90° and 120°

Item No.	Description	Case Qty	Packaging
10711	Multi-Use Trim Shears	6	Hang Card

# TileTrim Square™



- Features slots for holding metal trims, and profiles for 45° miter cuts
- V-groove for holding 1/4 rounds allows for a 45° miter cut, resulting in seamless inside and outside corners
- For use with wet saws and chop saws, and various cutting tools
- Works with 95% of tile trim in the market



Item No.	Description	Case Qty	Packaging
10715-6	TileTrim Square™	6	Shelf Case



SCAN HERE FOR PRODUCT VIDEO

# TILETRIM SQUARE™



2024 top flooring products  
**AWARD WINNER**  
for tools and equipment



## Tile Mallet



- Measures 70-75 on the Shore A hardness scale, for a firm hardness with minimum bounce when striking
- Designed for installing tile, vinyl, laminate and wood flooring
- Large chamfered mallet head spreads force across the flooring to move it into place during installation
- 16 oz. white rubber head with co-molded plastic 11½" handle with non-slip, rubber grip

Item No.	Description	Case Qty	Packaging
61625	Tile Mallet	3	Hang Handle

## White Rubber Mallet

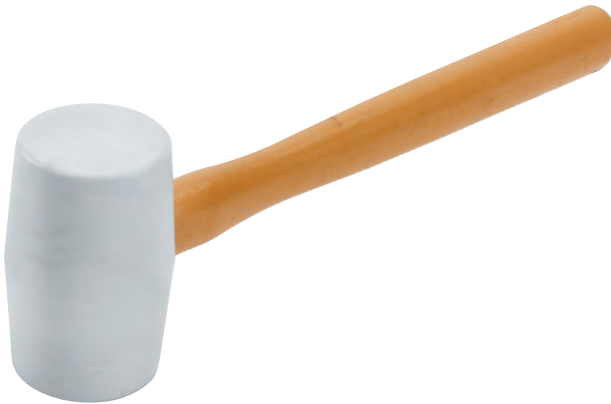

- 16 oz. rubber head securely mounted on hardwood handle
- 12½" in length, 2" diameter rubber head

Item No.	Description	Case Qty	Packaging
61613	White Rubber Mallet	12	Shelf Case

## **X-TREME**™ Cement Backer Board

Available as Full Container Orders Only,  
Drop Ship Only!



- Zero Fire & Smoke Rating
- Mold, mildew and water resistant
- A better environmental alternative and upgrade to replace gypsum and cement backer board for walls, floors and countertops.
- Contains no silica, no asbestos, no VOC's, no harmful additives
- Contributes to LEED credits and NAHB Green Building Program Credits

Item No.	Description	Pallet Qty	Packaging
73000	Backerboard, 1/4" Thick, 36" x 60"	100	Pallet
73001	Backerboard, 1/4" Thick, 48" x 96"	70	Pallet
73002	Backerboard, 1/2" Thick, 36" x 60"	50	Pallet
73005	Backerboard, 1/8" Thick, 36" x 60"	200	Pallet

SCAN HERE FOR MORE PRODUCT INFORMATION



## Folding Backerboard Knife



- Carbide multi-tip design, ideal for puncture and scoring
- Serrated blade base for cutting mesh
- Designed to score all types of backerboards
- Folding design for storage and safe transport
- Strong, lightweight aluminum handle with liner lock

Item No.	Description	Case Qty	Packaging
10072	Folding Backerboard Knife	6	Hang Card

## Backerboard Scoring Knife



- Long lasting carbide tips for scoring backerboard
- 2 tips deliver accurate, straight cuts
- Non-slip, rubber grip handle for comfortable repeat use

Item No.	Description	Case Qty	Packaging
10058	Backerboard Scoring Knife	12	Hang Card

## Board Seam Tape



- For use in seaming all types of cement backerboard and tile underlayment
- Alkali resistant fiberglass mesh, self-adhesive tape – reduces taping time
- Resists tears and will not shrink

Item No.	Description	Case Qty	Packaging
99600	Board Seam Tape – 2" x 50' roll	24	Shelf Case
99605	Cement Board Seam Tape – 2" x 150' roll	18	Shelf Case

# All-Purpose Heavy Duty Sponge



- Durable polyurethane material with hydrophilic cell design provides greater liquid-holding capacity for faster grout clean up
- Top choice for removing wet and drying grout during floor and wall installation
- Perfect for residential, commercial, auto, boat and RV cleaning

3rd party independent laboratory testing shows that the **QEP Sponge OUTPERFORMS** other brands in Holding Capacity, Water Absorption, Elongation, Tensile and Tear Strength

Lab Test	QEP	Other	Results
<b>Durability, Anti-Flaking</b> <small>(grams: abrasion foam loss)</small>	<input checked="" type="checkbox"/> <b>0.71</b>	<input type="checkbox"/> <b>0.93</b>	<b>30% MORE Durable</b>
<b>Material Absorption</b> <small>(grams: water immersion)</small>	<input checked="" type="checkbox"/> <b>24.01</b>	<input type="checkbox"/> <b>14.69</b>	<b>Wipes Up to 63% MORE Material</b>
<b>Water Retention</b> <small>(grams of water/grams of foam)</small>	<input checked="" type="checkbox"/> <b>36.35</b>	<input type="checkbox"/> <b>28.5</b>	<b>27% MORE Water Holding Power</b>
<b>Tensile Strength</b> <small>(psi: peak break point)</small>	<input checked="" type="checkbox"/> <b>22</b>	<input type="checkbox"/> <b>14</b>	<b>57% STRONGER</b>
<b>Elongation</b> <small>(% of 1 in. center section before break point)</small>	<input checked="" type="checkbox"/> <b>274</b>	<input type="checkbox"/> <b>223</b>	<b>22% STRONGER</b>
<b>Tear Strength</b> <small>(pound force per inch)</small>	<input checked="" type="checkbox"/> <b>5.3</b>	<input type="checkbox"/> <b>4.3</b>	<b>Lasts 23% LONGER</b>

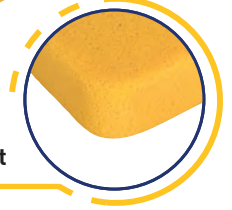

Rounded corners to prevent digging out or marring grout



Square corners provide maximum performance when working with narrow grout lines and tight corners

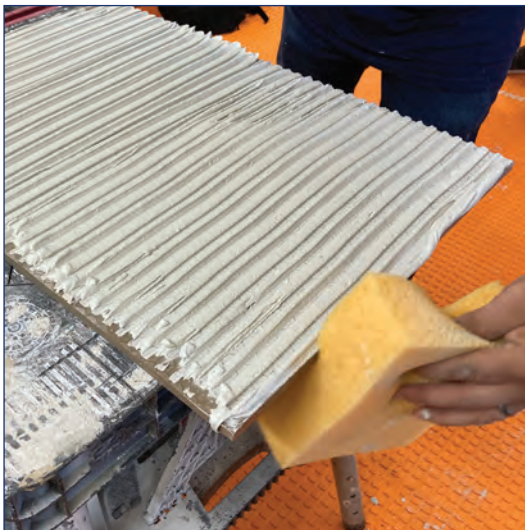

Rounded Corner - 7.5" x 5.5" x 1.875			
Item No.	Description	Case Qty	Packaging
70005-24	All-Purpose Heavy Duty Sponge, Individually bagged	24	Shelf Case
70005Q-6D	All-Purpose Heavy Duty Sponge, Value <b>6 Pack</b>	24	Shelf Case
70005-750	All-Purpose Heavy Duty Sponge, Bulk Bale	750	Bale
70005D	All-Purpose Heavy Duty Single Pack Sponge Display	252	Floor Display
70005-3VPD	All-Purpose Heavy Duty <b>3 Pack</b> Sponge	84	Floor Display

QEP Canada Only			
Item No.	Description	Case Qty	Packaging
70005	XL All-Purpose Sponge, Bulk Bale	600	Bale
70005C-24	XL All-Purpose Sponge, Individually bagged	24	Shelf Case

Square Corner - 6.75" x 4.625" x 2.375"			
Item No.	Description	Case Qty	Packaging
70006-18	Pro Square Grouting Sponge, Individually bagged	18	Shelf Case

## Epoxy Sponge

**NEW**



- Designed for epoxy grout clean-up during tile installation
- Professional, heavy duty sponge with high-density for removing excess grout
- Removes epoxy haze without scratching tile, polished porcelain and glass
- Rounded corner design prevents digging out or marring grout
- 7" x 5" x 2½"



Item No.	Description	Case Qty	Packaging
70020-18	Epoxy Sponge	18	Shelf Case
<b>QEP Canada Only</b>			
70020C-18	Epoxy Sponge - Only available in Canada	18	Shelf Case

## Scrubbing Sponge



- Durable polyurethane material with hydrophilic cell design provides greater liquid-holding capacity for the initial grout clean up on one side
- Powerful scrubbing side to combat difficult residues
- Rounded corners to prevent digging out or marring grout
- Perfect for residential, commercial, auto, boat and RV cleaning
- 7½" x 5¼" x 1⅞"



Item No.	Description	Case Qty	Packaging
70007-24	Scrubbing Sponge, Individually bagged	24	Shelf Case
<b>QEP Canada Only</b>			
70007C-24	Scrubbing Sponge, Individually bagged - Only available in Canada	24	Shelf Case

## Microfiber Polishing Sponge



- Durable polyurethane material with hydrophilic cell design provides greater liquid-holding capacity for the initial grout clean up on one side
- Microfiber side ideal for grout haze removal, applying sealer and polishing tile
- Rounded corners to prevent digging out or marring grout
- Perfect for residential, commercial, auto, boat and RV cleaning
- 7½" x 5½" x 2"



Item No.	Description	Case Qty	Packaging
70010	Microfiber Polishing Sponge	24	Shelf Case
<b>QEP Canada Only</b>			
70010C-24	Microfiber Polishing Sponge - Only available in Canada	24	Shelf Case

## Microfiber Grout Cleaning Cloth



- Oversized, microfiber cloth for removing grout haze, as well as general dusting, washing and cleaning
- Soft, yet durable and heavy weight material is great for wet or dry use
- 100% microfiber cloth, including double sided edge stitching
- Machine washable, and great for general purpose cleaning on most home surfaces, including cars and boats

Item No.	Description	Case Qty	Packaging
70018	Microfiber Grout Cleaning Cloth 18" x 18"	12	Hang Card

## Polishing Cheesecloth



- For removing grout haze after installation
- 5 square yards (36" x 180")
- Great for polishing most tile surfaces to a bright shiny finish
- 100% cotton, professional grade fine mesh

Item No.	Description	Case Qty	Packaging
76030	Polishing Cheesecloth	12	Hang Card

## Heavy Duty Plastic Mixing Bucket



- Heavy duty 5-gallon bucket with lifting capacity up to 84 lbs
- Reinforced ring design allows several buckets to nest and separate easily
- Sturdy wire bail with a plastic handgrip for easy lifting
- Versatile for job sites, gardening and general use



Item No.	Description	Case Qty	Packaging	Pallet Qty
78105	QEP Heavy Duty 5 Gallon Plastic Mixing Bucket - White	1	Open Stock	108

## Large Handle Scrub Brush



- Features corner brush head design
- Stiff nylon V cut bristles for cleaning deep into grout
- Built in scraper for tough dirt and grime
- Swivel head pole attachment allows for use standing up and provides additional leverage

Item No.	Description	Case Qty	Packaging
20839	Large Handle Scrub Brush	8	Hang Card

## Grout Cleaning Brush



- Multi-purpose cleaning brush with outstanding performance on tile and grout
- Ergonomic handle includes thumb rest for leverage and comfort
- Durable, angled nylon bristles remove grime in creases

Item No.	Description	Case Qty	Packaging
20842	Grout Cleaning Brush	12	Hang Card

## Heavy Duty Multipurpose Gloves



- Chemical resistant - protects hands from the corrosive action of grout, chemicals and other harsh substances
- 100% heavy duty latex is puncture and tear resistant
- One size fits most
- Non-slip ribbing on thumb and finger surfaces



Item No.	Description	Case Qty	Packaging
21591	Heavy Duty Multipurpose Gloves	24	Shelf Case

## SureGrip Tiler's Gloves



- Provides excellent grip and dexterity when handling tile and stone
- Patented SureGrip® technology provides an over 400% better grip in wet conditions and 60% better grip in dry conditions compared to standard latex and nitrile material
- Durable, lightweight mesh fabric with elastic wrist band to keep gloves in place
- Touchscreen compatible for easy smartphone and tablet use without removing gloves
- 2 pair of gloves per set
- One size fits most

Item No.	Description	Case Qty	Packaging
21595	SureGrip® Tiler's Gloves (2 pairs of gloves)	10	Shelf Case

⚠ WARNING: Cancer and Reproductive Harm - www.P65Warnings.ca.gov. See P. 89, \*Prop 65 - 1.

## Floor & Wall Tile Installation Kit

**SAVINGS  
ON KIT  
14%**



- Complete kit containing all the tools necessary to install ceramic tile on floors
- Kit contains:
  - Double-sided trowel:  $\frac{3}{16}$ " X  $\frac{5}{32}$ " V notch
  - $\frac{1}{4}$ " X  $\frac{1}{4}$ " X  $\frac{1}{4}$ " Square notch
  - Comfort Grip 6" x 2" Margin Float
  - Sponge
  - Tear resistant, reinforced grip multipurpose gloves
  - Washable kneepads
  - Reusable 2.5 gallon plastic bucket

Item No.	Description	Case Qty	Packaging
78251	Floor & Wall Tile Installation Kit	1	Bucket

## Tile Installation Kit

**SAVINGS  
ON KIT  
15%**



- Complete kit containing all the tools necessary to install ceramic tile on floors
- Kit contains:
  - Molded rubber float
  - $\frac{1}{4}$ " x  $\frac{3}{8}$ " x  $\frac{1}{4}$ " square notch floor trowel
  - 8" tile nippers, sponge, disposable gloves
  - Reusable 2.5 gallon plastic bucket
  - Complete installation instructions

Item No.	Description	Case Qty	Packaging
78220Q	Tile Installation Kit	1	Bucket
<b>QEP Canada Only</b>			
78220QC	Tile Installation Kit	1	Bucket

## Toilet Installation Kit & Accessories

- Includes: Harvey No-Seep® No. 50 Extra Thick Wax Ring with alignment flange, Fluidmaster® 12" SS Braided Toilet Connector, Bolt Kit -  $\frac{1}{4}$ " x 2 $\frac{1}{4}$ " brass-plated closet bolts with nuts and washers

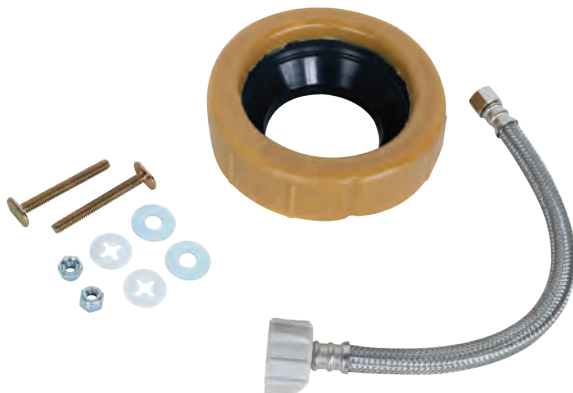

Item No.	Description	Case Qty	Packaging
38229	Toilet Installation Kit with 12" Connector	1	Shelf Case

# PRECISE POWERFUL ADJUSTABLE VERSATILE

ROBERTS® Super Six and Longneck Plus 6" Jamb Saws are powerful and versatile tools that meet a wide variety of undercutting needs.

From doorjamb and molding to under toekicks and undercut doors, we're ready for all of your flooring installation needs

Featuring adjustable cutting depth guides, to prevent cutting into plaster or wallboards, and precision height specifications allowing cuts from flush to 1 1/16" above the floor.

Our ROBERTS Jamb Saws help get the job done right.



10-56  
LONGNECK PLUS  
6" JAMB SAW



10-46  
SUPER SIX  
6" JAMB SAW



Scan here for  
PRODUCT  
INFORMATION

10-46 Super Six  
6" Jamb Saw



10-56 Longneck Plus  
6" Jamb Saw



 **ROBERTS**

Supporting Professional Installers Since 1938



[robertsconsolidated.com](http://robertsconsolidated.com)

866.435.8665



## TEAR-OUT TOOLS

When starting a new project, QEP knows scrapers and chisels need to be strong and durable to get the job done. We offer smaller handheld options, chisels and scrapers that can accommodate handles for extended reach and traditional demolition, surface and floor scrapers. All of these tools are designed for better leverage, comfort and control while working.

# 4" Carbon Steel Floor Scraper

**NEW**



**2-Pack REPLACEMENT BLADES**

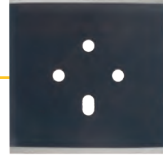

62935 (Sold Separately)

- Carbon steel blade for superior strength and shock resistance
- Die-cast aluminum scraping head provides maximum blade support
- Non-slip foam provides comfortable grip for better leverage
- Ergonomic Non-Slip D handle for improved grip and reduced hand strain
- Rotatable blade has 2 sharp edges for tough jobs and 2 blunt edges for easy clean up



Item No.	Description	Case Qty	Packaging
62934-3	4" Carbon Steel Floor Scraper	3	Hang Card
62935	Replacement Blades 2 pack	10	Hang Card

# 14" Surface Scraper



- Flexible carbon steel blade for removing old floors and cleaning up excess debris
- All welded construction made of pipe steel with a replaceable flexible blade
- Great for removing tile, vinyl, carpet glue, plaster and popcorn ceilings
- 5' long handle for leverage

Item No.	Description	Case Qty	Packaging
20900Q	14" Surface Scraper	6	Hang Card
21000Q	14" Replacement Blade	3	Hang Card
<b>QEP Canada Only</b>			
20900C	14" Surface Scraper	6	Hang Card

## 7" Heavy Duty Floor Scraper

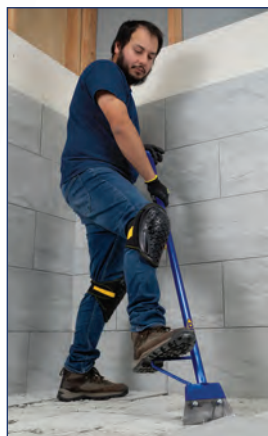

- Rigid carbon steel blade for scraping up ceramic tile, concrete, marble, and wood floors
- All welded construction made of pipe steel with a replaceable rigid blade
- Rips up roofing and vinyl flooring; chips away cement and plaster
- 4' long handle includes foot peg for better leverage on difficult projects
- Also great for ice removal

Item No.	Description	Case Qty	Packaging
75006Q	7" Heavy-Duty Floor Scraper	6	Hang Card
75007Q	7" Replacement Blade	3	Hang Card
<b>QEP Canada Only</b>			
75017C	7" Heavy-Duty Floor Scraper	6	Hang Card

## 8" Adjustable Razor Floor Scraper



- 15° angled stainless steel blade head for removing old adhesive, vinyl, carpet and other flooring materials
- All welded construction made of pipe steel with a replaceable blade
- Twist lock adjustable telescoping handle adjusts from 3' to 6' in length
- Deluxe cushioned grip handle provides added comfort when scraping

Item No.	Description	Case Qty	Packaging
62909Q	8" Adjustable Razor Floor Stripper	6	Hang Card
62909-12	8" Adjustable Razor Floor Stripper Canvas Cover- replacement	1	Plastic Bag
<b>Replacement Blades</b>			
62904Q	8" Stripper Blades (3 on a skincard)	10	Hang Card
62907Q	8" Stripper Blades (10 on a skincard)	1	Hang Card
<b>QEP Canada Only</b>			
62909QC	8" Adjustable Razor Floor Stripper	6	Hang Card

## 4" Razor Scraper



- Handle features internal blade storage and built-in screwdriver for easy accessibility
- Attach handle to a threaded pole for an extended reach
- Metal hammer end for use on stubborn material
- Includes five 4" stainless steel blades
- Co-molded plastic handle core with non-slip, rubber grip

Item No.	Description	Case Qty	Packaging
62920	4" Razor Scraper	6	Hang Card
<b>Replacement Blades</b>			
62901	4" Razor Scraper Blades (5 on a skincard)	6	Hang Card

## **XTREME** PRO-SERIES Heavy Duty Chisel Scraper



- Features over strike impact guard
- Industrial grade with rust preventative coating
- Precision ground cutting edge
- Shock-absorb handle features non-slip grip for added control

Item No.	Description	Case Qty	Packaging
62971	Xtreme Heavy Duty Chisel	4	Hang Card

SCAN HERE FOR MORE PRODUCT INFORMATION



## Chisel Scraper



- Heavy duty 3" stainless steel blade
- Attach handle to a threaded pole for an extended reach
- End of handle features a metal cap which can be struck with a rubber mallet for stubborn material
- Co-molded plastic handle core with non-slip, rubber grip

Item No.	Description	Case Qty	Packaging
62972	Chisel Scraper	6	Hang Card



## KNEE PADS

Offering installers several designs for knee protection, QEP prioritizes your time and safety. From EVA foam and memory foam to encapsulated gel layers, we've got you covered. Most QEP kneepads also offer convenient side loops for pen storage to quickly make marks.

# ProMAXGel Knee Pads



- Gel layer is fully encapsulated in EVA foam to prevent delamination and minimize wear
- Textured cap surface for a non-slip grip and moisture-wicking neoprene liner for comfort
- Micro hook and loop fastening technology down the length of the strap for a perfect fit
- Convenient side pen loops for pen storage

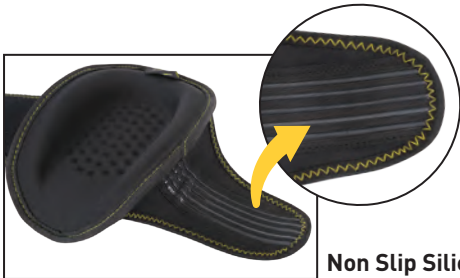

Non Slip Silicone Grips

Item No.	Description	Case Qty	Packaging
79645	ProMAX® Gel Knee Pads	6	Hang Card Shelf Case

# Comfort Grip Knee Pads



- Comfortable EVA form-fitting foam padding for cushioning
- Soft neoprene inner lining will not adsorb sweat so the knee pads won't develop an odor
- Stretching, neoprene strap with adjustable hook and loop fasteners hold the knee pads in place
- Convenient side pen loops for pen storage



Item No.	Description	Case Qty	Packaging
79634	Comfort Grip Knee Pads	8	Hang Card Shelf Case

## Comfort Wrap Technology *with Memory Foam*



- Memory foam conforms to your knee shape for a custom fit
- XL Patella Gel Zone and 5 Layer Comfort System provides extended total knee comfort
- Soft Cap Stabilizer for hard or soft surfaces
- Micro hook and loop fastening technology on the entire strap length for a perfect fit
- Convenient side pen loops for pen storage



Item No.	Description	Case Qty	Packaging
79642	F3 Stabilizer Professional Knee Pads	6	Hang Card Shelf Case

## Washable Knee Pads



- Compression molded EVA foam for easy washing with a neoprene liner for comfort
- Economical and lightweight for comfort and easy mobility
- Adjustable hook and loop fastening straps hold the knee pads in place



Item No.	Description	Case Qty	Packaging
79640	Washable Knee Pads	14	Hang Card



# UNDERLAYMENTS & BARRIERS

QEP offers both cork underlayments and Aquabar® "B" Moisture Vapor Barrier to enhance crack suppression. Natural Cork Underlayments help control sound under ceramic tile and stone and reduce thermal transmissions.

# Benefits of Cork Underlayment



A staple in green building, cork offers superior durability, is impermeable, resistant to mold, mildew, and termites. A natural insulator, cork is fire resistant, and provides unrivaled noise reduction properties.

Our cork sheets and rolls exceed the International Building Code requirements for ambient and impactsound transmission. Cork is an excellent resource for underlayment, and comes from a renewable resource. Cork underlayment is carbon negative and is the exceptional choice.

Using cork underlayment contributes to LEED Green Building Credits.



**EASY TO INSTALL**



**NATURAL BARRIER**



**CRACK SUPPRESSION**



**INSULATING**



**SOUND ABSORBING**

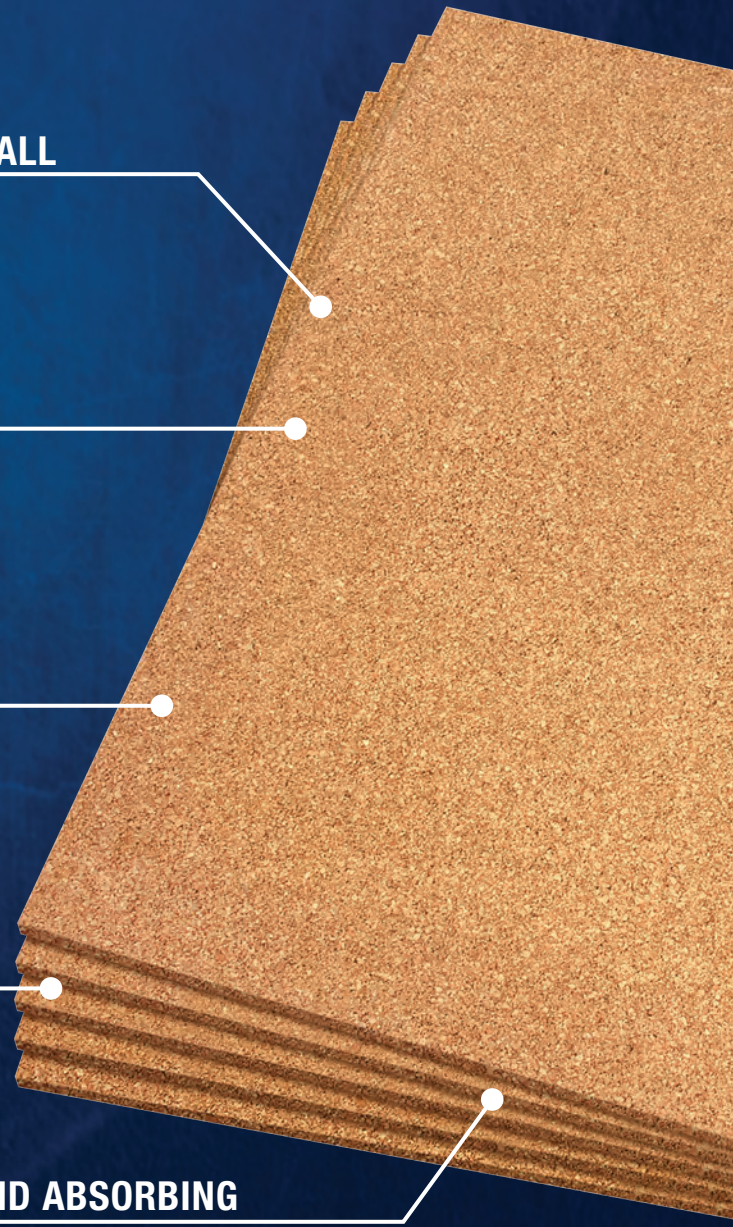

## Natural Cork Sheets



- Reduces sound transmission from both the surface of a floor as well as through the floor to living spaces below
- Use under ceramic tile, stone, marble, engineered hardwood and laminate floors
- Acts as a crack isolation membrane that resists transfer of stress cracks from subfloor through to flooring surfaces
- Reduces thermal transmission, increasing the effectiveness of floor heating systems
- Each sheet: 2' x 3'



	Test Results	IIC Rating*	STC Rating**	Δ Rating***
72005Q	With 6" cement slab & suspended ceiling	74	70	22

Item No.	Description	Case Qty	Packaging
72005Q	1/4" (6 mm) Sheets - 30 sq. ft./pack, (5 sh/pk)	8	Shelf Case
72001Q	1/2" (12 mm) Sheets - 150 sq. ft./case, (25 sh/cs)	1	Shelf Case

## Natural Cork Roll



- Reduces sound transmission from both the surface of a floor as well as through the floor to living spaces below
- Use under ceramic tile, stone, marble, engineered hardwood and laminate floors
- Acts as a crack isolation membrane that resists transfer of stress cracks from subfloor through to flooring surfaces
- Reduces thermal transmission, increasing the effectiveness of floor heating systems



	Test Results	IIC Rating*	STC Rating**	Δ Rating***
72000Q	With 6" cement slab & suspended ceiling	74	70	22
72003Q	With 6" cement slab & suspended ceiling	74	70	22

Item No.	Description	Case Qty	Packaging
72000Q	1/4" (6 mm) Natural Cork 200 sq. ft. roll, 48" x 50'	1	Roll
72003Q	1/4" (6 mm) Natural Cork 100 sq. ft. roll, 48" x 25'	1	Roll

## Aquabar® "B" Moisture Vapor Barrier



- Sub-floor barrier helps prevent buckling, cupping and cracking
- Ideal for interior installations of: ceramic, porcelain or stone over cement board, plywood or concrete; and, finished or unfinished wood floors over plywood or concrete

Item No.	Description	Case Qty	Packaging
70-195	Aquabar "B" Moisture Vapor Barrier - 500 sq. ft., 36" x 167'	1	Roll

\*IIC measures sound such as moving furniture and walking, \*\*STC measures sound such as voices and television. Minimum sound rating required by most building codes and architects is 50. \*\*\*Δ Delta Rating is the only true measurement of sound reduction from a product (not a floor assembly) in the industry.



# DISPLAYS & MERCHANDISING

We are pleased to offer both promotional floor stands and permanent fixtures for some of our best-selling installation tools. The floor displays are made of cardboard which can be recycled and the countertop displays can be used for any QEP product you would like to feature. Our 4' and 8' QEP branded gondola fixtures are designed to hold pegged product, shelf cartons and boxes. The gondola presentation allows for the full range of QEP tile tools to be merchandised together with overhead signage.



# Corrugated Floor Displays

## Single Pack Sponge

Professional, heavy duty sponge for grout clean-up

**252**  
Sponges  
per display



70005D  
Heavy Duty All Purpose  
Single Pack Sponge Floor Display



## 3-Pack Sponge

Foam density is engineered for quicker grout pick-up and faster rinse

**84**  
3-packs  
per display



70005 -3VPD  
Heavy Duty All-Purpose  
3-Pack Sponge Floor Display



## Square Sponge

Square corners for maximum performance when working with narrow grout lines and tight corners

**255**  
Sponges  
per display



70006D  
Pro Square  
Grouting Sponges  
Floor Display



# Corrugated Floor Displays

## Mixers

24" Pro Mixing Paddle  
for fast effective and mixing of  
grouts, thinsets and other materials

**30**  
Mixers  
per display



61205D  
Pro Mixing Paddle  
Floor Display



## LASH® Project Pack

Project Pack includes:  
• 100 1/16"  
Flat Tile Leveling Clips  
100 Leveling Wedges

**48**  
Project Packs  
per display

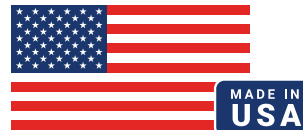

99741D  
LASH® Project Pack  
Floor Display



## LASH 360® Project Pack

LASH 360® Tile Leveling System  
Project Pack Includes:  
100 1/16" Posts  
100 Caps

**24**  
Project Packs  
per display

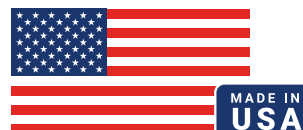

99735DU  
LASH 360® Project Pack  
Floor Display



# LASH XL™ Tile Leveling Clips and Wedges Pallets

Tile Leveling Clips and Wedges in Pallet quantities

Large Format Design for tiles up to 1/2" thick

Available in 4 grout widths



**96**  
cases  
500 count  
clips  
per pallet

**64**  
cases  
500 count  
wedges  
per pallet

## 500 Count

Order the following to fill pallets:

Clips: 96 boxes

Wedges: 64 boxes

See page 37 for details on each sku



# LASH XL™ Tile Leveling Clips and Wedges Pallets

Tile Leveling Clips and Wedges in Pallet quantities

Large Format Design for tiles up to 1/2" thick Available in 4 grout widths



## 2000 Count Clips



**24**  
cases  
2000 count  
clips  
per pallet

## 1000 Count Wedges

**15**  
cases  
1000 count  
wedges  
per pallet



Order the following to fill pallets:

Clips: 24 boxes

Wedges: 15 boxes

See page 38 for details on each sku

# LASH 360® Tile Leveling System

Cap and post both on one pallet! Available in 4 grout widths

**LASH 360®**  
LEVEL ALIGN SPACE HOLD



## Tile Leveling System 300 Count Boxes

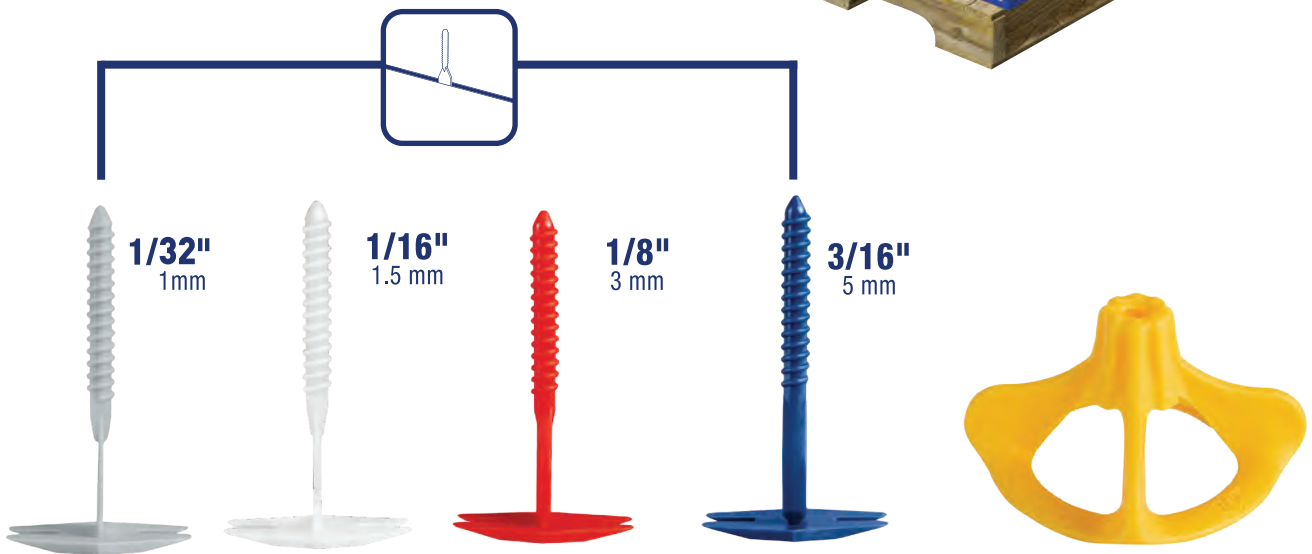

Order the following to fill pallets:

300 count Caps: 30 boxes

300 count Posts: 72 boxes

See page 39 for details on each sku

## Tile Tool Merchandising Displays

QEP is pleased to offer free displays that can be customized based on the product assortment of top-selling tools you carry! These portable gondolas are designed and merchandised to deliver incremental sales at high margins. Includes free branded header insert.

### 4' Tile Tool Merchandising Display



- Header is adjustable and measures 48" wide x 10" tall
- Display measures 48" wide x 26" deep x 72" high

**FREE**  
**Display**  
with opening order

**\$500**  
**Value**

See your Sales Rep for more details

QEP 4' Gondola  
Item # QEP4FTGONDOLA  
Sign - Item # 1170-361

← Example of 4' Planogram

### 8' Tile Tool Merchandising Display

- Header is adjustable and measures 96" wide x 10" tall
- Display measures 96" wide x 26" deep x 72" high

**FREE**  
**Display**  
with opening order

**\$1000**  
**Value**

See your Sales Rep for more details



QEP 8' Gondola  
Item # QEP8FTGONDOLA  
Sign - Item # 1170-351

Example of 8' Planogram →



## Tile Tool Merchandising Displays

QEP is pleased to offer counter top displays that can be customized based on the product assortment you carry! These displays should be merchandised near check out for incremental sales. All displays includes free branded header insert.



## Counter Display



- Vertical display measures 18.85" wide x 15.68" deep x 33.75" high
- QEP Xtreme Hole Saws are an example of product assortment that can be displayed on this fixture.

Item # HSCTD4W  
Sign # HSCTD4SIGN

**FREE Display**  
with opening order

**\$48 Value**

See your Sales Rep for more details



## Katana Tile Cutter Display & Header



- Display measures 18" wide x 29" deep x 62" high
- Comes with pre printed header sign

**FREE Display**  
with opening order

**\$472 Value**

See your Sales Rep for more details

Katana Sign and Display  
Item # KatanaFixture

## Gravity Display



- Silicone injected hook design allows product to slide to front
- Vertical display measures 27.28" wide x 11.92" deep x 18.70" high
- QEP Xtreme Hole Saws are an example of product assortment that can be displayed on this fixture.

Item # HSCTD5W  
Sign # HSCTD5SIGN

**FREE  
Display**  
with opening order

**\$52  
Value**

See your Sales Rep for more details

## Trowel Shelves



- Display measures 11" wide x 5' deep x 4' high

Item # TCDSIPLAY

**FREE  
Display**  
with opening order

**\$30  
Value**

See your Sales Rep for more details

## INDEX *By Item Number*

Item #	Description	Page
10003	Tile Nipper	58
10005	1/4" Tile Spacers, Bag - 200 Qty	40
10020	Grout Remover	64
10022	Rubbing Stone 6" x 2" x 1"	59
10027	3/8" Tile Spacers, Bag - 100 Qty	40
10038	6" Locking Contour Gauge	59
10046	60 Grit Sanding Block	51
10047	120 Grit Sanding Block	51
10048	200 Grit Sanding Block	51
10049	400 Grit Sanding Block	51
10051	Xtreme 3/8" Diamond Milling Bit	51
10052	Xtreme 3/4" Diamond Milling Bit	51
10057	Grout Saw	57
10058	Backerboard Scoring Knife	68
10060	Molded Rubber Grout Float 9-1/2" x 4"	47
10062	Grout Float 9" x 4"	47
10066	Xtreme 1-1/2" Diamond Milling Cone	51
10069	Xtreme Stone Grout Float, 10" x 4"	46
10070	Gum Rubber Grout Float, Wood Handle, 10-1/2" x 4"	47
10071	Xtreme 3/16" Diamond Hole Saw	51
10072	Folding Backerboard Knife	68
10074-8	Universal Float 9-1/2" x 4"	46
10075	Xtreme 1/4" Diamond Hole Saw	49
10080	Xtreme 5/16" Diamond Hole Saw	49
10087	Xtreme 1-3/8" Diamond Hole Saw	49
10088	Diamond Grit Grout Removal Curved Blade	50
10089	Diamond Grit Grout Removal Linear Blade	50
10093	Pro Grout Saw	55
10113	Standard Trowel Square Notch 1/4" x 1/4" x 1/4"	44
10114	Standard Trowel Square Notch 1/4" x 3/8" x 1/4"	44
10115	Standard Trowel V Notch 3/16" x 5/32"	44
10116	Standard Trowel V Notch 1/4" x 3/16" (Canada Only)	44
10120	Standard Trowel Square Notch 1/2" x 1/2" x 1/2"	44
10152	50 Grit 4" Dry Polishing Pad	52
10153	100 Grit 4" Dry Polishing Pad	52
10154	200 Grit 4" Dry Polishing Pad	52
10155	400 Grit 4" Dry Polishing Pad	52
10156	4" Rubber Backing Pad	52
10157	4 Piece Polishing Pad Set	52
10158	800 Grit 4" Dry Polishing Pad	52
10159	1500 Grit 4" Dry Polishing Pad	52
10161	3000 Grit 4" Dry Polishing Pad	52
10162	Buff Polishing Pad	52
10202	1/16" "T" Tile Spacers, Bag - 300 Qty	40
10203	1/8" "T" Tile Spacers, Bag - 300 Qty	40
10204	3/16" "T" Tile Spacers, Bag - 200 Qty	40

Item #	Description	Page
10279	Grout Sealer Applicator	65
10285	Soft Wedge Tile Spacers 1/8", Bag - 500 Qty	39
10310	Katana SR-31 Tile Cutter	17
10320	1/16" Horseshoe Shims - 200 Qty	39
10321	1/8" Horseshoe Shims - 150 Qty	39
10322	3/16" Horseshoe Shims - 100 Qty	39
10323	1/4" Horseshoe Shims - 75 Qty	39
10324	1/16" Leave-In Spacers, Jar - 1500 Qty	40
10325	1/8" Leave-In Spacers, Jar - 1000 Qty	40
10326	3/16" Tile Spacers, Jar - 500 Qty	40
10332	3/16" Leave-In Spacers, Bag - 200 Qty	40
10333	1/4" Leave-In Spacers, Bag - 200 Qty	40
10334	1/16" Tile Spacers*, Bag - 300 Qty	40
10335	1/8" Tile Spacers*, Bag - 500 Qty	40
10336	3/16" Tile Spacers*, Bag - 300 Qty	40
10348	Hard Wedge Tile Spacer 3/16" , Jar - 500 Qty	39
10410	Katana SR-41 Tile Cutter	16
10451	1/8" Paver Spacers 20 pack	39
10468	Xtreme 3/16" Hole Saw for grinder	50
10469	Xtreme 1/4" Hole Saw for grinder	50
10470	Xtreme 5/16" Hole Saw for grinder	50
10471	Xtreme 1" Hole Saw for grinder	50
10472	Xtreme 1-3/8" Hole Saw for grinder	50
10473	Xtreme 2" Hole Saw for grinder	50
10474	Xtreme 2-1/2" Hole Saw for grinder	50
10475	Xtreme 4" Hole Saw for grinder	50
10476	Grind Shield - 3 Pack	54
10485	Xtreme wax/DRY Diamond Hole Saw Kit	51
10500	22-1/2" Big Clinker Tile Cutter	18
10569	1-3/8" Porcelain Diamond Hole Saw w/Drill Guide and Water Cooling System	54
10570	1-3/8" Hole Saw Extra Mounting Tape	54
10585	3" Diamond Jigsaw Blade	54
10600	25" Big Clinker Tile Cutter	18
10630	24" Tile Cutter	20
10711	Multi-Use Trim Shears	65
10800	28" Big Clinker Tile Cutter	18
10900	35" Tile Cutter	20
19999	Grout Sealer Brush Applicator	65
20839	Large Handle Scrub Brush	72
20842	Grout Cleaning Brush	72
21125	7/8" Tile Cutter Replacement Scoring Wheel with Ball Bearings	22
21131	7/8" Titanium-Coated Tungsten Carbide Ball Bearing Scoring Wheel	22
21178	7/8" Titanium-Coated Tungsten Carbide Scoring Wheel	19
21178	7/8" Titanium-Coated Tungsten Carbide Scoring Wheel	22
21591	Heavy Duty Multipurpose Gloves	72
21595	SureGrip® Tiler's Gloves	72

Item #	Description	Page
21661	24" Pro Mixing Paddle	61
21700	Power Mixer Pro w/ Paddle	60
32016	Xtreme Artisan Power Tile Nipper	57
32024	Tile Cutter	58
32036	Compound Tile Nipper	58
38229	Toilet Installation Kit with 12" Connector	73
38779	Wax China Markers - 2 Pack - 1 black/1 red	59
42112	6" x 2" Comfort Grip Margin Trowel No Notch	45
42114	6" x 2" Comfort Grip Margin Trowel Square Notch 1/4" x 1/4" x 1/4"	45
42117	6" Comfort Grip Margin Float	45
49708	Patch & Finishing Trowel 11" x 4-1/2" No Notch	44
49713	Wood Handle Trowel Square Notch 1/4" x 1/4" x 1/4"	43
49714	Wood Handle Trowel Square Notch 1/4" x 3/8" x 1/4"	43
49716	Wood Handle Trowel V Notch 1/4" x 3/16"	43
49720	Wood Handle Trowel Square Notch 1/2" x 1/2" x 1/2"	43
61205	24" Pro Mixing Paddle	61
61210	16" Universal Mixing Paddle	61
61230	30" XL Spiral Pro Mixer	61
61613	White Rubber Mallet	67
61625	Tile Mallet	67
62901	4" Razor Scraper Blades (5 on a skincard)	78
62920	4" Razor Scraper	78
62935	Replacement Blades 2 pack	78
62963	Thinset Removal Tool	66
62971	Xtreme Heavy Duty Chisel	78
62972	Chisel Scraper	78
70005	XL All-Purpose Sponge, Bulk Bale (Canada Only)	69
70010	Microfiber Polishing Sponge	70
70018	Microfiber Grout Cleaning Cloth 18" x 18"	71
73000	Backerboard, 1/4" Thick, 36" x 60"	67
73001	Backerboard, 1/4" Thick, 48" x 96"	67
73002	Backerboard, 1/2" Thick, 36" x 60"	67
73005	Backerboard, 1/8" Thick, 36" x 60"	67
75000	Suction Cup	64
75003	Double Suction Cup	63
75011	Replacement Grout Saw Blades 2 pack	55
75011	Replacement Grout Saw Blades 2 pack	55
75013	ProMAX® Grip Double Suction Cup	63
75018	Xtreme Rough Surfaces Double Suction Cup	63
75019	Xtreme Rough Surfaces Single Suction Cup	63
75021	8" Vacuum Pump Suction Cup	62
75022	8" Pump Suction Cup with Gauge	62
75024	Xtreme Pro Series 8" Electric Suction Cup	62
75025	GPTP™ Rail Cutting System	8
75027	GPTP™ Folding Work Table	10
75028	GPTP™ Carrying System	12
75029	GPTP™ Transport Cart	13
75031	GPTP™ Vibrating Suction Cup	14

Item #	Description	Page
75033	GPTP™ Tile Beater Block	14
76000	Grout Bag	65
76030	Polishing Cheesecloth	71
78105	QEP® Heavy Duty 5 Gallon Plastic Mixing Bucket - White	71
78251	Floor & Wall Tile Installation Kit	73
79634	Comfort Grip Knee Pads	80
79640	Washable Knee Pads	81
79642	F3 Stabilizer Professional Knee Pads	81
79645	ProMAX® Gel Knee Pads	80
83249	49" Bridge Saw – 10" Blade	24
99600	Board Seam Tape – 2" x 50' roll	68
99605	Cement Board Seam Tape – 2" x 150' roll	68
99712	LASH 360® 3/16" Posts	38
99726	LASH® Wedges - 100 Qty	36
99727	LASH® Wedges - 300 Qty	36
99728	LASH® Wedges - 500 Qty	36
99730	LASH® Clips 1/16" - 100 Qty	36
99731	LASH® Clips 1/16" - 300 Qty	36
99735	LASH 360® 1/16" Posts - 100 Qty	38
99738	LASH 360® 1/32" Posts - 100 Qty	38
99739	LASH 360® 1/8" Posts - 100 Qty	38
99740	LASH® Clips 1/16" - 1000 Qty	36
99741-6	LASH® Project Pack 100 Clips 1/16" - 100 Wedges (200 Qty)	36
99742	LASH 360® Caps - 100 Qty	38
99751	LASH XL™ 1/32" Leveling Clips - 100 Qty	37
99761	LASH XL™ 1/16" Leveling Clips - 100 Qty	37
99762	LASH XL™ Leveling Wedges - 100 Qty	37
99769	LASH XL™ 1/8" Leveling Clips - 100 Qty	37
99771	LASH XL™ 1/32" Leveling Clips - 500 Qty	37
99772	LASH XL™ 1/16" Leveling Clips - 500 Qty	37
99773	LASH XL™ 1/8" Leveling Clips - 500 Qty	37
99774	LASH XL™ 3/16" Leveling Clips - 500 Qty	37
99775	LASH XL™ Leveling Wedges - 500 Qty	37
99776	LASH XL™ 1/32" Leveling Clips - 2000 Qty	37
99777	LASH XL™ 1/16" Leveling Clips - 2000 Qty	37
99778	LASH XL™ 1/8" Leveling Clips - 2000 Qty	37
99779	LASH XL™ 3/16" Leveling Clips - 2000 Qty	37
99781	LASH® Clips 1/8" - 100 Qty	36
99782	LASH® Clips 1/8" - 300 Qty	36
99783	LASH® Clips 1/8" - 1000 Qty	36
99784	Pro Installation Pliers	36
99790	LASH® Clips 1/16" - 500 Qty	36
99791	LASH® Clips 1/8" - 500 Qty	36
99792	LASH® Clips 1/16" - 2000 Qty	36
99793	LASH® Clips 1/8" - 2000 Qty	36
99812	LASH 360® 1/8" Posts - 300 Qty	38
99835	LASH 360® 1/16" Posts - 300 Qty	38

Item #	Description	Page
99837	LASH 360® 1/16" Posts - 1000 Qty	38
99838	LASH 360® 1/32" Posts - 1000 Qty	38
99839	LASH 360® 1/8" Posts - 1000 Qty	38
99840	LASH 360® 3/16" Posts - 1000 Qty	38
99841	LASH 360® Caps - 1000 Qty	38
99842	LASH 360® Caps - 300 Qty	38
99843	LASH 360® 1/32" Posts - 300 Qty	38
99844	LASH 360® 3/16" Posts - 300 Qty	38
99861	LASH XL™ 1/16" Leveling Clips - 300 Qty	37
99862	LASH XL™ Leveling Wedges - 300 Qty	37
99869	LASH XL™ 1/8" Leveling Clips - 300 Qty	37
99871	LASH XL™ 1/32" Leveling Clips - 1000 Qty	37
99872	LASH XL™ 1/16" Leveling Clips - 1000 Qty	37
99873	LASH XL™ 1/8" Leveling Clips - 1000 Qty	37
99880	LASH XL™ Leveling Wedges - 2000 Qty	37
99971	LASH XL™ 1/32" Leveling Clips - 300 Qty	37
10-46	Super Six 6" Jamb Saw	74
10-56	Longneck Plus 6" Jamb Saw	74
10010HD	1/2" Tungsten Carbide Scoring Wheel	22
10074-8	Universal Float 9-1/2" x 4"	46
10075-8	Xtreme 1/4" Diamond Hole Saw 8 pk	49
10080-8	Xtreme 5/16" Diamond Hole Saw 8 pk	49
10087-8	Xtreme 1-3/8" Diamond Hole Saw 8 pk	49
10214Q	14" Tile Cutter	21
10220Q	20" Tile Cutter	21
10221Q	21" Tile Cutter	21
10330-20	1/16" Leave-In Spacers, Bag - 300 Qty	40
10331-18	1/8" Leave-In Spacers, Bag - 300 Qty	40
10480Q	48" LFT Manual Cutter	20
10586-6	Diamond Grit File	55
10624Q	24" Slimline Manual Tile Cutter, with 2 legs	19
10632Q	30" Slimline Manual Tile Cutter, with 2 legs (Canada Only)	19
10636Q	36" Slimline Manual Tile Cutter, with 4 legs	19
10715-6	TileTrim Square™	66
1170-351	QEP® 8' Gondola Sign	91
1170-361	QEP® 4' Gondola Sign	91
20900C	14" Surface Scraper (Canada Only)	76
20900Q	14" Surface Scraper	76
21000Q	14" Replacement Blade	76
21123Q	7/8" Titanium-Coated Tungsten Carbide Ball Bearing Scoring Wheel	22
21127Q	10 mm Post Scoring Wheel	22
22400Q	4" Torque Master XT Portable Wet Tile Saw	27
22700Q	7" 700XT Tile Wet Saw	27
22900Q	7" Power Pro 1HP Wet Tile Saw	26
42113-6	Bucket Scoop	45
49915-12	Comfort Grip Stainless Steel Trowel Square Notch 1/4" x 1/4" x 1/4"	43
49916-12	Comfort Grip Stainless Steel Trowel Square Notch 1/4" x 3/8" x 1/4"	43

Item #	Description	Page
49917-12	Comfort Grip Stainless Steel Trowel V Notch 3/16" x 5/32"	43
49918-12	Comfort Grip Stainless Steel Trowel Euro Notch (available in Canada)	43
49919-12	Comfort Grip Stainless Steel Trowel Square Notch 1/2" x 1/2" x 1/2"	43
49920-12	Comfort Grip Stainless Steel Trowel Slant Notch	43
49950-12	Xtreme Cork Handle Trowel Square Notch 1/4" x 1/4" x 1/4"	43
49951-12	Xtreme Cork Handle Trowel Square Notch 1/4" x 3/8" x 1/4"	43
49952-12	Xtreme Cork Handle Trowel Square Notch 1/2" x 1/2" x 1/2"	43
49953-12 (Canada Only)	Xtreme Cork Handle Trowel with ruler Square Notch 1/4" x 1/4" x 1/4"	43
49954-12 (Canada Only)	Xtreme Cork Handle Trowel with ruler Square Notch 1/4" x 3/8" x 1/4"	43
49955-12 (Canada Only)	Xtreme Cork Handle Trowel with ruler Square Notch 1/2" x 1/2" x 1/2"	43
49956-12	Xtreme Cork Handle Trowel Euro Notch (available in Canada)	43
49957-12	Xtreme Cork Handle Trowel Slant Notch	43
6-4006GLQ	4" Continuous Rim	31
6-7007GL	7" Continuous Rim	31
61205D	24" Pro Mixing Paddle Display	61
61205D	Pro Mixing Paddle Floor Display	87
62904Q	8" Stripper Blades (3 on a skincard)	77
62907Q	8" Stripper Blades (10 on a skincard)	77
62909-12	8" Adjustable Razor Floor Stripper Canvas Cover- replacement	77
62909Q	8" Adjustable Razor Floor Stripper	77
62909QC	8" Adjustable Razor Floor Stripper (Canada Only)	77
62934-3	4" Carbon Steel Floor Scraper	76
7-1003Q	10" Continuous Rim	33
7-1004H	10" Hot Dog Blade	30
7-1007SG	XTREME 10" Segmented Blade	29
7-1008BW	10" Black Widow®	31
7-1009MH	XTREME 10" Mesh Blade	30
7-3006TB	XTREME 3-3/8" Turbo Blade	30
7-3009MH	XTREME 3-1/4" Mesh Blade	30
7-4003Q	4" Continuous Rim	33
7-4004H	4" Hot Dog Blade	32
7-4008BW	4" Black Widow®	31
7-7003Q	7" Continuous Rim	33
7-7004H	7" Hot Dog Blade	32
7-7007SG	XTREME 7" Segmented Blade	29
7-7008BW	7" Black Widow®	31
7-7009MH	XTREME 7" Mesh Blade	30
7-8003Q	8" Continuous Rim	33
7-8008BW	8" Black Widow®	31
70-195	Aquabar "B" Moisture Vapor Barrier - 500 sq. ft., 36" x 167'	84
70005-3VPD	Heavy Duty All-Purpose 3-Pack Sponge Floor Display	86
70005-24	All-Purpose Heavy Duty Sponge, Individually bagged	69
70005-3VPD	All-Purpose Heavy Duty 3 Pack Sponge	69
70005-750	All-Purpose Heavy Duty Sponge, Bulk Bale	69

Item #	Description	Page	Item #	Description	Page
70005C-24	XL All-Purpose Sponge, Individually bagged (Canada Only)	69	78220Q	Tile Installation Kit	73
70005D	All-Purpose Heavy Duty Single Pack Sponge Display	69	78220QC	Tile Installation Kit (Canada Only)	73
70005D	Heavy Duty All Purpose Single Pack Sponge Floor Display	86	99735DU	LASH 360® Project Pack Floor Display	87
70005Q-6D	All-Purpose Heavy Duty Sponge, Value 6 Pack	69	99741-6	LASH® Project Pack - 100 1/16" clips/100 Wedges	38
70006-18	Pro Square Grouting Sponge, Individually bagged	69	99741D	LASH® Project Pack Floor Display	87
70006D	Pro Square Grouting Sponges Floor Display	86	99833-6	Tile Leveling System Protection Plate	38
70007-24	Scrubbing Sponge, Individually bagged	70	HSCTD4SIGN	QEP® Counter Display Sign	92
70007C-24	Scrubbing Sponge, Individually bagged (Canada Only)	70	HSCTD4W	QEP® Counter Display	92
70010C-24	Microfiber Polishing Sponge (Canada Only)	70	HSCTD5SIGN	QEP® Gravity Display Sign	95
70020-18	Epoxy Sponge	70	HSCTD5W	QEP® Gravity Display	95
70020C-18	Epoxy Sponge (Canada Only)	70	KatanaFixture	QEP® Katana Tile Cutter Display & Header	94
72000Q	1/4" (6 mm) Natural Cork 200 sq. ft. roll, 48" x 50'	84	QEP4FTGONDOLA	QEP® 4' Gondola	93
72001Q	1/2" (12 mm) Sheets - 150 sq. ft./case, (25 sh/cs)	84	QEP8FTGONDOLA	QEP® 8' Gondola	93
72003Q	1/4" (6 mm) Natural Cork 100 sq. ft. roll, 48" x 25'	84	TCDSIPLAY	Trowel Shelves	93
72005Q	1/4" (6 mm) Sheets - 30 sq. ft./pack, (5 sh/pk)	84			
75001Q	23-1/2" Thinset and Grout Mixing Paddle	61			
75006Q	7" Heavy-Duty Floor Scraper	77			
75007Q	7" Replacement Blade	77			
75017C	7" Heavy-Duty Floor Scraper (Canada Only)	77			

**Proposition 65** is a California regulatory law that requires businesses to notify California consumers about specific chemicals in the products they purchase so they can make informed decisions about protecting themselves from exposure to these chemicals. This law requires companies to properly label products that contain chemical(s) above certain threshold levels.

As part of QEP Co. Inc.'s continued best business practice and compliance program, we comply with Proposition 65 warning requirements and provide product-associated warnings. We are dedicated to meeting consumer product safety requirements applicable to our products and strive to provide high quality and safe products.

For more information on California Proposition 65, go to [www.P65Warnings.ca.gov](http://www.P65Warnings.ca.gov).

**\*Prop 65 - 1. ⚠️ WARNING:** This product can expose you to chemicals including Lead which is known to the State of California to cause cancer, birth defects or other reproductive harm.

QEP®, LASH® and Black Widow® are registered trademarks of QEP Co., Inc.

Xtreme™, Hot Dog™ Grind Sheild™, GPTP™ and Gauged Porcelain Tile Panel Solutions™ are trademarks of QEP Co., Inc.

Katana™ is a trademarks of QEP Co., Inc.

Aquabar® "B" is a registered trademark of Fortifiber LLC.

Fluidmaster® is a registered trademark of Fluidmaster, Inc.

No-Seep® is a registered trademark of William H. Harvey Co.

ROBERTS® Max Complete® is a registered trademark of Roberts Consolidated Industries, Inc.

Rug Gripper™ is a trademark of Optimum Technologies, Inc.

## QEP® WARRANTY



All QEP electric tile saws, mixers, tile cutters, and the electric suction cup carry a 3 year Manufacturer's Limited Warranty. The Manufacturer's Limited Warranty ensures the product is free from defects in materials and workmanship for a period of 3-years from the date of purchase. This warranty does not cover accidental damages, unreasonable or improper use, normal wear and tear, loss of use, or consequential damages. Product registration, included with the product packaging, must be completed within 30 days of purchase for eligibility. This warranty covers refund or replacement due to a defect in materials or workmanship for a term of the warranty.

All QEP hand tools carry a 1-year Manufacturer's Limited Warranty ensuring the product is free from defects in materials and workmanship for a period of 1-year from the date of purchase. This warranty does not cover accidental damages, unreasonable or improper use, normal wear and tear, loss of use, or consequential damages.



PROFESSIONAL  
**TOOLS.**  
PROFESSIONAL  
**RESULTS.**

**QEP**

1001 Broken Sound Parkway, NW  
Boca Raton, Florida 33487

qep.com | qepcorporate.com

For more information call 866-435-8665

Se habla español

SCAN HERE FOR  
ONLINE CATALOG



QEPTOOL2026 – A3026-01129

Our 2026 QEP catalog cover features the large format GTP™ Rail Cutting System